



INNOMOUNT – Montagesystem INNOMOUNT – Mounting Solution

GESAMTKATALOG / MAIN CATALOGUE 06/2026



- 4** **Waffenkennzahlen** / ID Number
- 6** **Artikelnummer** / Item Number
- 7** **ZF-Aufnahmen** / Scope supports
- 8** **Übersicht Optoelektronik**
Overview Optoelektronik
- 12** **Weaver/Picatinny**
Klassische Zieloptik / Classic optics
Reflexvisiere / Red Dot Sight
Optoelektronik / Optoelektronik
Optoelektronik Multifunktionsmontage /
Optoelektronik multi function mounts
- 26** **Blaser | Sauer 505**
Klassische Zieloptik / Classic optics
Reflexvisiere / Red Dot Sight
Optoelektronik / Optoelektronik
Optoelektronik Multifunktionsmontage /
Optoelektronik multi function mounts
- 34** **Blaser R8 Ultimate X**
Klassische Zieloptik / Classic optics
- 38** **Sauer 404**
Klassische Zieloptik / Classic optics
Reflexvisiere / Red Dot Sight
Optoelektronik / Optoelektronik
Optoelektronik Multifunktionsmontage /
Optoelektronik multi function mounts
- 46** **Sauer 303**
Klassische Zieloptik / Classic optics
Reflexvisiere / Red Dot Sight
Optoelektronik / Optoelektronik
- 52** **Tikka T3/T3X**
Klassische Zieloptik / Classic optics
Reflexvisiere / Red Dot Sight
Optoelektronik / Optoelektronik
- 58** **CZ 550/557**
Klassische Zieloptik / Classic optics
Optoelektronik / Optoelektronik
- 64** **Merkel**
Klassische Zieloptik / Classic optics
Reflexvisiere / Red Dot Sight
Optoelektronik / Optoelektronik
- 70** **12mm Prisma**
Klassische Zieloptik / Classic optics
- 72** **Multirail/Picatinnyrail**
Multirail/Picatinnyrail
- 73** **Basen - Weaver - Zweiteilig**
Bases - Weaver - two piece
- 74** **Abmessungen**
Dimensions
- 76** **Double Sight**
Double Sight
- 79** **Brückenschwenkmontagen**
Swing mounts
- 81** **Bestellbeispiel**
Order example
- 82** **Taktische Montagen - Flex**
Tactical mount - flex



WAFFENKENNZAHLEN

ID NUMBER

Bestellbeispiel:
70-SR-12-002-010-150-086

Weitere Bauhöhen:
70-SR-12-004-030-150-086
70-SR-12-006-050-150-086

Fabrikat	Modell	WKZ	Weaverbasen		Schwenkmontage - Oberteile			
			2tlg.	15mm Prisma - (-150)		EAW (-160)		
				Bauhöhe Vorderfuss* XXX	Bauhöhe Distanzrolle* YYY	Bauhöhe Vorderfuss* XXX	Bauhöhe Distanzrolle* YYY	
Anschütz	1574	154	x	002	025	004	010	
Anschütz	1780	151	x	002	010	006	015	
Anschütz	1770 / Match 54	001		002	010	006	015	
Anschütz	Match 64	028		002	010	006	015	
Antonio Zoli	1900 Reptierer	305	x	002	035	004	020	
Benelli	Argo	273	x	002	010	006	015	
BRNO	CZ531	965		002	040	004	025	
BRNO	Scandinavian	048		002	040	004	025	
BSA	Repetierer	927		002	040	004	025	
Carl Gustav	1900	005	x	002	035	004	020	
Carl Gustav	2000	194	x	002	010	206	015	
Carl Gustav	3000	215	x	002	010	006	015	
Carl Gustav	4000	259	x	002	010	006	015	
Fabarm	liris	403	x	002	010	006	015	
FN Browning	A-Bolt, Eurobolt	002		002	010	006	015	
FN Browning	BAR / MARAL	003	x	002	010	006	015	
FN Browning	BLR	103	x	002	010	006	015	
FN Browning	Brow Mauser	004	x	002	050	002	015	
FN Browning	European	143	x	002	010	006	015	
Haenel	Jäger 10, ab Nr. 921	226	x	206	080	206	045	
Heckler & Koch	SLB 2000-Light	187	x	002	010	006	015	
Heym	SR 20	060	x	002	050	002	015	
Heym	SR 21	306	x	206	065	206	030	
Heym	SR 30	206	x	206	065	206	030	
Howa	1500	218	x	206	080	206	045	
Kepplinger	Repetierer	955		002	040	004	025	
Krico	600,700,900,902	006	x	002	025	004	010	
Marlin	1895/444/338/336/308	036		002	010	006	015	
Mauser	97	029		002	030	004	015	
Mauser	225 Titan	145	x	002	035	004	020	
Mauser	94-96<	156		002	040	004	025	
Mauser	94-96>	256		002	030	004	015	
Mauser	K98 / M12	010	x	002	050	002	015	
Mauser	M18	007	x	206	080	206	045	
Merkel	SR 1	186	x	002	015	006	020	
Merkel	SR 1 Basic	286	x	002	010	006	015	
Parker Hale	Safari 1200	011		002	050	002	015	
Pfeifer	SR2	030		002	010	006	015	
Remington	700 short / long action	012	x	206	080	206	045	
Remington	7400-7600-750	013	x	002	010	006	015	
Remington	750/740/742/760	074	x	002	010	006	015	
Remington	Seven / 600/ 673	078		002	040	004	025	

Fabrikat	Modell	WKZ	Weaverbasen		Schwenkmontage - Oberteile			
			2tlg.	15mm Prisma - (-150)		EAW (-160)		
				Bauhöhe Vorderfuss* XXX	Bauhöhe Distanzrolle* YYY	Bauhöhe Vorderfuss* XXX	Bauhöhe Distanzrolle* YYY	
Rössler	Titan 16	031		206	070	206	035	
Rössler	Titan 6 / Titan 3	459	x	206	050	206	015	
Sabatti	Rover	155		002	040	004	025	
Santa Barbara	Mauser	044	x	002	050	002	015	
Sauer	200	059	x	002	010	006	015	
Sauer	100/101	014	x	206	080	206	045	
Sauer	202 Standard / Magnum	406	x	002	025	004	010	
Sauer	80,90,92	015	x	002	010	006	015	
Savage	110,116	016		206	050	206	015	
Schultz & Larsen	M 97 DL	199		002	030	004	015	
Steyr	Mod L	093	x	002	010	006	015	
Steyr	Mod M Luxus L M S	086	x	002	010	006	015	
Steyr	Mod M72	019		002	010	006	015	
Steyr	Mod SL	017	x	002	010	006	015	
Steyr	SBS96/SM12/Classic	027	x	002	010	006	015	
Tikka	T3(x)	400		002	010	006	015	
Swiss Arms	SHR 970	175	x	002	010	006	015	
Verney Carron	Auto Impact	405		002	025	004	010	
Verney Carron	L.A.	032		002	010	006	015	
Verney Carron	Repetierer	919		002	025	004	010	
Voere	Kuffstein 2165	021	x	002	050	002	015	
Voere	Automat 2185	141	x	002	010	006	015	
Voere	Titan II	045	x	002	035	004	020	
Weatherby	.240 Weath	058		002	025	004	010	
Weatherby	Mark V,Vanguard	023		206	080	206	045	
Winchester	M70 .223WQD	117		002	045	002	010	
Winchester	Mod 70	024		002	045	002	010	
Zastava	Mini Mauser	107		002	040	004	025	
Zastava	Mod 70	049	x	002	050	002	015	

* kleinstmögliche Bauhöhen
* minimum construction heights



ARTIKELNUMMER

ITEM NUMBER

Montagetyp / Mounting type

Oberteil / Upper part

Bauhöhe / Construction height
Angaben in mm / dimensions in mm

Kröpfung / Offset
Angaben in mm / dimensions in mm

Waffenkennzahl / Weapon code

Vorneigung / Pre-tilt
Angaben in MOA / data in MOA

50-SR-07-00-200-20MOA

- 40 - ZERO einteilig
- 41 - ZERO zweiteilig
- 44 - ZERO zweiteilig variabel
- 45 - ZERO multifunktional
- 50 - QD einteilig
- 51 - QD zweiteilig
- 52 - QD Reflexvisiere
- 53 - FM einteilig
- 54 - QD zweiteilig variabel
- 55 - QD multifunktional
- 56 - FM zweiteilig variabel
- 57 - FM zweiteilig

- LM - 70° Prismenschiene
- PT - Picatinny
- SR - Swarovskischiene
- SB - S&B Convexschiene
- VM - Zeisschiene
- ...

- 100 - INNOGUN
- 200 - Weaver / Picatinny
- 400 - Tikka T3/T3x
- 520 - CZ 550 / CZ 557
- 600 - Sauer 303
- 650 - Sauer 404
- 800 - Blaser | Sauer 505
- 850 - Blaser R8 Ultimate X
- 900 - Merkel B3 / B4 / KR1 / K3 / K5
- 950 - 12 mm Prisma

- 26 - Ringe 25,4/26 mm
- 30 - Ringe 30 mm
- 34 - Ringe 34 mm
- 35 - Ringe 35 mm
- 36 - Ringe 36 mm
- 40 - Ringe 40 mm

ZF-AUFNAHMEN

SCOPE SUPPORTS

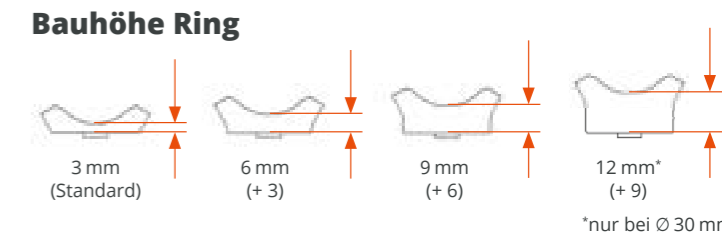
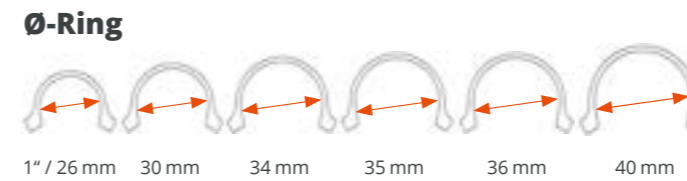
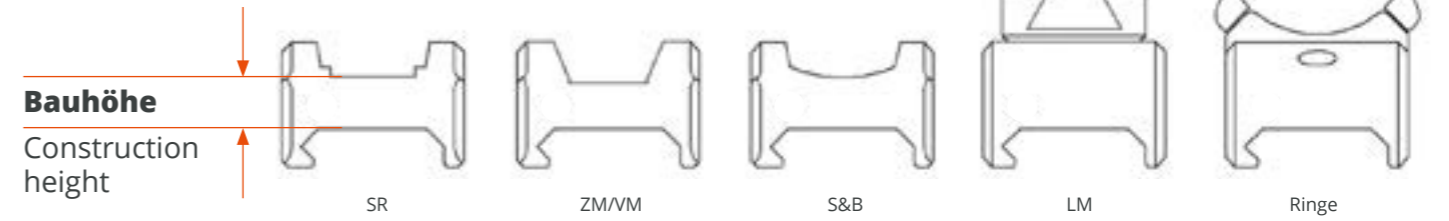

Richtige Bauhöhe

Correct construction height

Richtige Bauhöhe? Verstellturmunterseite beachten!
Correct construction height? Turret bottom!

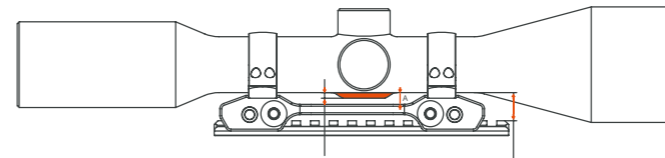

Modell / model	A (mm) Ring standard
Weaver/Picatinny einteilig (200)	6
Tikka T3/T3x (400)	6
CZ 550 (520)	4
Sauer 303 (600)	4

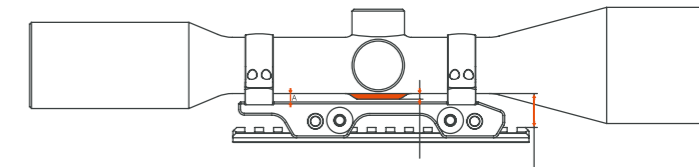

Modell / model	A (mm) Ring standard
Innogun (100)	1,5
Blaser Sauer 505 (800)	1,5
Merkel (900)	1,5
12 mm - Prisma (950)	1,5
Weaver/Picatinny einteilig gekröpft (200)	1,5
Weaver/Picatinny zweiteilig variabel (200)	3
Sauer 404 (650)	1,5

Verschlussarten

Detachment Systems



QD - Schnellspanverschluss
QD - Quick Detach



ZERO - Schnellspanverschluss
ZERO - Quick Detach



FM - Festverschluss
FM - Fix Detach

ÜBERSICHT OPTOELEKTRONIK

OVERVIEW OPTOELEKTRONIC



AR
Archer TSA



ATN
Thor | Mars | X-Sight I + II
ATN 4 / ATN 5
Thor 4 | Thor LT | X-Sight 4K Pro
X-Sight LTV | X-Sight 4K INT



GST
BTC35/50



CTA
Avata 635 | 650 | 650LIIR
CTP
Polaris 335R | 335RL | 350R
350RL | 635R 635RL | 650R
650RL
TH
Night Arrow



TH
Sight 35
IRX
Scope Elite 50



IRS
Sperber 19 | 25 | 35
IRX
Sperber 50 | 64



IRS
Fox 19 Hunt | Fox 35 Elite II
Fox 35 Hunt
TH
Marten TU 420 | Marten TU 430
Marten TU 450 | Marten TU 650



TH
ACE H50R | H50 | L35
Bolt L35R | P25R
DE
ACE S60R | ACE S60R | Nite D70R
IRS
Mate Lite | H38R | H50R | Ultra
Slim H35 | L35



DH
Hunter



H2
Hydra II
VI
Visir



FG
Fortuna General
FG1
Fortuna General One



GSWH
Wolfhound



PA
APEX | Digisight | Trail
PA2
Trail 2 | LRF
Digisight Ultra N355
Digisight Ultra N450 / LRF
Digisight Ultra N455 / LRF
TH
Pulsar Thermion I+II/Pro/LRF
Thermion Duo DXP50 | DXP55
DE
Digex N450 | N455 | C50
TN
Pulsar Talion XQ38 | XG35 | Trail 3



PD
NV008P | NV008P LRF
SA 19 | 25 | 35 | 45 LRF
PD2
NV008S | NV008S LRF
FT32 LRF
DE
DS35
TH
DS35 LRF | Nightstalker 4K
Pantera 480/640/640 Zoom



TH
Pegasus/Pegasus Pro
Volans V850 | V850LRF
PX
Chiron



PD
HT 60 | XM



GT
TS 450
TH
TU 420 | TU 430 | TU 450
TU 620 | TU 630 | TU 650



HMT
Thunder TH 25 | TH 35 | TE 19 PRO
TE 25 PRO | TQ 35 PRO | TQ 50 PRO
Panther PH 35L | PH 50L | PQ 35L
PQ 50L
Cheetah C32F-S | SL | SN | SNL
HMT2
Thunder TE19 C | TE19 C 2.0
TH35 C | TH35 PC | TH35 PC 2.0
TQ35 C | TQ35 C 2.0 | TQ50 C
TQ50 C 2.0
TH
Alpex 4K Lite A40EL
Stellar SH35 | 50 | SQ35/50
Stellar 2.0 SQ50
Stellar 3.0 SH35 | SH35L | SH50L
SQ35L | SQ50L | SX60L
DE
Alpex A50EL
Alpex A50T | A50TN
Alpex Pro A50P | Pro A50PL
Stellar SX60L 3.0
SE30
Neos NE25 | NH25L | NH35L



IRR
Rico RH 35 | RH 50 | RL 42
RS 75 | Rico 2 S75R | H75R
Geni GL35R | GL35 | GH50
GH50R
IRS
Saim SCP 19 | SCL 35 | SCT 35
SCH 50 | SCT 35 V2
TH
Tube TL 35 | TH 35 | TH 35 SE
TH 50 | TS 60
IRX
Xsight SH 50 | SL 50
DE
Tube TD 50L | Tube TH 50 V2
SE26 | SE30
Tube TL25 SE | TL35 SE
HY
Hybrid



GST
TA435/450



TH
Ares 335 | 360 | 635 | 660
Ibex 335L
Oryx-L635 | L650
TV
Vidar 335 | 350 | 360 | 635
650 | 660 | Vidar 335L | 350L
360L | 635L | 650L | 660L



YP
Photon
PA
Sightline N455S
Sightline N475S



ZT
Zentron Q35 | Q635 | Q50 | Q50R



FÜR **WEAVER/PICATINNY**

FÜR WEAVER/PICATINNY (200)

¹ Auch passend für Merkel Helix / Steel Action / Sako S20 / Benelli Lupo / Anschütz 1782 / Haenel Jaeger EVO/NXT / CZ 600 / für Steyr MS | RMS Wild / ...

Länge Picatinnysschiene ≥ 140 mm; Abstand der Klemmachsen 110 mm

¹ Also fits Merkel Helix / Steel Action / Sako S20 / Benelli Lupo / Anschütz 1782 / Haenel Jaeger EVO/NXT / CZ 600 / ...
length of Picatinny rail ≥ 140 mm; Distance between clamping axes 110 mm

² Auch passend für Strasser / Benelli Argo / ... / Länge Picatinnysschiene ≥ 115 mm; Abstand der Klemmachsen 85 mm

² Also fits Strasser / Benelli Argo / ... / length of Picatinny rail ≥ 115 mm; Distance between clamping axes 85 mm

³ Auch passend für Länge Picatinnysschiene ≥ 85 mm; Abstand der Klemmachsen 58 mm

³ Also fits length of Picatinny rail ≥ 85 mm; Distance between clamping axes 58 mm

	Bauhöhe	Zero	QD	FM	Ansicht QD
--	---------	------	----	----	------------

RINGMONTAGE 1"/26 MM

	Bauhöhe	Zero	QD	FM	Ansicht QD
einteilig	BH 14 BH 17 BH 20	40-26-14-00-200 40-26-17-00-200 40-26-20-00-200	50-26-14-00-200 50-26-17-00-200 50-26-20-00-200	53-26-14-00-200 53-26-17-00-200 53-26-20-00-200	
einteilig 20 MOA	BH 14 BH 17 BH 20	40-26-14-00-200-20MOA 40-26-17-00-200-20MOA 40-26-20-00-200-20MOA	50-26-14-00-200-20MOA 50-26-17-00-200-20MOA 50-26-20-00-200-20MOA	53-26-14-00-200-20MOA 53-26-17-00-200-20MOA 53-26-20-00-200-20MOA	
einteilig gekröpft	BH 14 BH 17 BH 20	40-26-14-25-200 40-26-17-25-200 40-26-20-25-200	50-26-14-25-200 50-26-17-25-200 50-26-20-25-200	53-26-14-25-200 53-26-17-25-200 53-26-20-25-200	
einteilig gekröpft 20 MOA	BH 14 BH 17 BH 20	40-26-14-25-200-20MOA 40-26-17-25-200-20MOA 40-26-20-25-200-20MOA	50-26-14-25-200-20MOA 50-26-17-25-200-20MOA 50-26-20-25-200-20MOA	53-26-14-25-200-20MOA 53-26-17-25-200-20MOA 53-26-20-25-200-20MOA	
zweiteilig	BH 14 BH 17 BH 20	41-26-14-00-200 41-26-17-00-200 41-26-20-00-200	51-26-14-00-200 51-26-17-00-200 51-26-20-00-200	57-26-14-00-200 57-26-17-00-200 57-26-20-00-200	
zweiteilig gekröpft	BH 14 BH 17 BH 20	41-26-14-25-200 41-26-17-25-200 41-26-20-25-200	51-26-14-25-200 51-26-17-25-200 51-26-20-25-200	57-26-14-25-200 57-26-17-25-200 57-26-20-25-200	
zweiteilig variabel	BH 20 BH 23 BH 26	44-26-20-00-200 44-26-23-00-200 44-26-26-00-200	54-26-20-00-200 54-26-23-00-200 54-26-26-00-200	56-26-20-00-200 56-26-23-00-200 56-26-26-00-200	

RINGMONTAGE 30 MM

	Bauhöhe	Zero	QD	FM	Ansicht QD
einteilig	BH 14 BH 17 BH 20 BH 23	40-30-14-00-200 40-30-17-00-200 40-30-20-00-200 40-30-23-00-200	50-30-14-00-200 50-30-17-00-200 50-30-20-00-200 50-30-23-00-200	53-30-14-00-200 53-30-17-00-200 53-30-20-00-200 53-30-23-00-200	
einteilig 20 MOA	BH 14 BH 17 BH 20 BH 23	40-30-14-00-200-20MOA 40-30-17-00-200-20MOA 40-30-20-00-200-20MOA 40-30-23-00-200-20MOA	50-30-14-00-200-20MOA 50-30-17-00-200-20MOA 50-30-20-00-200-20MOA 50-30-23-00-200-20MOA	53-30-14-00-200-20MOA 53-30-17-00-200-20MOA 53-30-20-00-200-20MOA 53-30-23-00-200-20MOA	
einteilig gekröpft	BH 14 BH 17 BH 20 BH 23	40-30-14-25-200 40-30-17-25-200 40-30-20-25-200 40-30-23-25-200	50-30-14-25-200 50-30-17-25-200 50-30-20-25-200 50-30-23-25-200	53-30-14-25-200 53-30-17-25-200 53-30-20-25-200 53-30-23-25-200	
einteilig gekröpft 20 MOA	BH 14 BH 17 BH 20 BH 23	40-30-14-25-200-20MOA 40-30-17-25-200-20MOA 40-30-20-25-200-20MOA 40-30-23-25-200-20MOA	50-30-14-25-200-20MOA 50-30-17-25-200-20MOA 50-30-20-25-200-20MOA 50-30-23-25-200-20MOA	53-30-14-25-200-20MOA 53-30-17-25-200-20MOA 53-30-20-25-200-20MOA 53-30-23-25-200-20MOA	
zweiteilig	BH 14 BH 17 BH 20 BH 23	41-30-14-00-200 41-30-17-00-200 41-30-20-00-200 41-30-23-00-200	51-30-14-00-200 51-30-17-00-200 51-30-20-00-200 51-30-23-00-200	57-30-14-00-200 57-30-17-00-200 57-30-20-00-200 57-30-23-00-200	
zweiteilig gekröpft	BH 14 BH 17 BH 20 BH 23	41-30-14-25-200 41-30-17-25-200 41-30-20-25-200 41-30-23-25-200	51-30-14-25-200 51-30-17-25-200 51-30-20-25-200 51-30-23-25-200	57-30-14-25-200 57-30-17-25-200 57-30-20-25-200 57-30-23-25-200	
zweiteilig variabel	BH 20 BH 23 BH 26 BH 29	44-30-20-00-200 44-30-23-00-200 44-30-26-00-200 44-30-29-00-200	54-30-20-00-200 54-30-23-00-200 54-30-26-00-200 54-30-29-00-200	56-30-20-00-200 56-30-23-00-200 56-30-26-00-200 56-30-29-00-200	

	Bauhöhe	Zero	QD	FM	Ansicht QD
--	---------	------	----	----	------------

RINGMONTAGE 34 MM

	Bauhöhe	Zero	QD	FM	Ansicht QD
einteilig	BH 14 BH 17 BH 20 BH 23	40-34-14-00-200 40-34-17-00-200 40-34-20-00-200 40-34-23-00-200	50-34-14-00-200 50-34-17-00-200 50-34-20-00-200 50-34-23-00-200	53-34-14-00-200 53-34-17-00-200 53-34-20-00-200 53-34-23-00-200	
einteilig 20 MOA	BH 14 BH 17 BH 20 BH 23	40-34-14-00-200-20MOA 40-34-17-00-200-20MOA 40-34-20-00-200-20MOA 40-34-23-00-200-20MOA	50-34-14-00-200-20MOA 50-34-17-00-200-20MOA 50-34-20-00-200-20MOA 50-34-23-00-200-20MOA	53-34-14-00-200-20MOA 53-34-17-00-200-20MOA 53-34-20-00-200-20MOA 53-34-23-00-200-20MOA	
einteilig gekröpft	BH 14 BH 17 BH 20 BH 23	40-34-14-25-200 40-34-17-25-200 40-34-20-25-200 40-34-23-25-200	50-34-14-25-200 50-34-17-25-200 50-34-20-25-200 50-34-23-25-200	53-34-14-25-200 53-34-17-25-200 53-34-20-25-200 53-34-23-25-200	
einteilig gekröpft 20 MOA	BH 14 BH 17 BH 20 BH 23	40-34-14-25-200-20MOA 40-34-17-25-200-20MOA 40-34-20-25-200-20MOA 40-34-23-25-200-20MOA	50-34-14-25-200-20MOA 50-34-17-25-200-20MOA 50-34-20-25-200-20MOA 50-34-23-25-200-20MOA	53-34-14-25-200-20MOA 53-34-17-25-200-20MOA 53-34-20-25-200-20MOA 53-34-23-25-200-20MOA	
zweiteilig	BH 14 BH 17 BH 20 BH 23	41-34-14-00-200 41-34-17-00-200 41-34-20-00-200 41-34-23-00-200	51-34-14-00-200 51-34-17-00-200 51-34-20-00-200 51-34-23-00-200	57-34-14-00-200 57-34-17-00-200 57-34-20-00-200 57-34-23-00-200	
zweiteilig gekröpft	BH 14 BH 17 BH 20 BH 23	41-34-14-25-200 41-34-17-25-200 41-34-20-25-200 41-34-23-25-200	51-34-14-25-200 51-34-17-25-200 51-34-20-25-200 51-34-23-25-200	57-34-14-25-200 57-34-17-25-200 57-34-20-25-200 57-34-23-25-200	
zweiteilig variabel	BH 20 BH 23 BH 26 BH 29	44-34-20-00-200 44-34-23-00-200 44-34-26-00-200 44-34-29-00-200	54-34-20-00-200 54-34-23-00-200 54-34-26-00-200 54-34-29-00-200	56-34-20-00-200 56-34-23-00-200 56-34-26-00-200 56-34-29-00-200	

RINGMONTAGE 35 MM

	Bauhöhe	Zero	QD	FM	Ansicht QD
einteilig	BH 14 BH 17 BH 20	40-35-14-00-200 40-35-17-00-200 40-35-20-00-200	50-35-14-00-200 50-35-17-00-200 50-35-20-00-200	53-35-14-00-200 53-35-17-00-200 53-35-20-00-200	
einteilig 20 MOA	BH 14 BH 17 BH 20	40-35-14-00-200-20MOA 40-35-17-00-200-20MOA 40-35-20-00-200-20MOA	50-35-14-00-200-20MOA 50-35-17-00-200-20MOA 50-35-20-00-200-20MOA	53-35-14-00-200-20MOA 53-35-17-00-200-20MOA 53-35-20-00-200-20MOA	
einteilig gekröpft	BH 14 BH 17 BH 20	40-35-14-25-200 40-35-17-25-200 40-35-20-25-200	50-35-14-25-200 50-35-17-25-200 50-35-20-25-200	53-35-14-25-200 53-35-17-25-200 53-35-20-25-200	
einteilig gekröpft 20 MOA	BH 14 BH 17 BH 20	40-35-14-25-200-20MOA 40-35-17-25-200-20MOA 40-35-20-25-200-20MOA	50-35-14-25-200-20MOA 50-35-17-25-200-20MOA 50-35-20-25-200-20MOA	53-35-14-25-200-20MOA 53-35-17-25-200-20MOA 53-35-20-25-200-20MOA	
zweiteilig	BH 14 BH 17 BH 20	41-35-14-00-200 41-35-17-00-200 41-35-20-00-200	51-35-14-00-200 51-35-17-00-200 51-35-20-00-200	57-35-14-00-200 57-35-17-00-200 57-35-20-00-200	
zweiteilig gekröpft	BH 14 BH 17 BH 20	41-35-14-25-200 41-35-17-25-200 41-35-20-25-200	51-35-14-25-200 51-35-17-25-200 51-35-20-25-200	57-35-14-25-200 57-35-17-25-200 57-35-20-25-200	
zweiteilig variabel	BH 20 BH 23 BH 26	44-35-20-00-200 44-35-23-00-200 44-35-26-00-200	54-35-20-00-200 54-35-23-00-200 54-35-26-00-200	56-35-20-00-200 56-35-23-00-200 56-35-26-00-200	

*Axialanschlag 5 mm (optional 3,8 mm) *Axial stop 5mm (optional 3,8 mm) | **Axialanschlag 3,8 mm (optional 5 mm) **Axial stop 3,8 mm (optional 5 mm)

FÜR **WEAVER/PICATINNY** (200)

¹ Auch passend für Merkel Helix / Steel Action / Sako S20 / Benelli Lupo / Anschütz 1782 / Haenel Jaeger EVO/NXT / CZ 600 / für Steyr MS | RMS Wild / ...
Länge Picatinnysschiene ≥ 140 mm; Abstand der Klemmachsen 110 mm

¹ Also fits Merkel Helix / Steel Action / Sako S20 / Benelli Lupo / Anschütz 1782 / Haenel Jaeger EVO/NXT / CZ 600 / ...
 length of Picatinny rail ≥ 140 mm; Distance between clamping axes 110 mm

² Auch passend für Strasser / Benelli Argo / ... / **Länge Picatinnysschiene ≥ 115 mm; Abstand der Klemmachsen 85 mm**

² Also fits Strasser / Benelli Argo / ... / length of Picatinny rail ≥ 115 mm; Distance between clamping axes 85 mm







³ Auch passend für **Länge Picatinnysschiene ≥ 85 mm; Abstand der Klemmachsen 58 mm**

³ Also fits length of Picatinny rail ≥ 85 mm; Distance between clamping axes 58 mm

	Bauhöhe	Zero	QD	FM	Ansicht QD
--	---------	------	----	----	------------







RINGMONTAGE 36 MM

Ø 36

Ø 36	einteilig	BH 14 BH 17 BH 20	40-36-14-00-200 40-36-17-00-200 40-36-20-00-200	50-36-14-00-200 50-36-17-00-200 50-36-20-00-200	53-36-14-00-200 53-36-17-00-200 53-36-20-00-200	 ^{1*}
	einteilig 20 MOA	BH 14 BH 17 BH 20	40-36-14-00-200-20MOA 40-36-17-00-200-20MOA 40-36-20-00-200-20MOA	50-36-14-00-200-20MOA 50-36-17-00-200-20MOA 50-36-20-00-200-20MOA	53-36-14-00-200-20MOA 53-36-17-00-200-20MOA 53-36-20-00-200-20MOA	 ^{1*}
	einteilig gekröpft	BH 14 BH 17 BH 20	40-36-14-25-200 40-36-17-25-200 40-36-20-25-200	50-36-14-25-200 50-36-17-25-200 50-36-20-25-200	53-36-14-25-200 53-36-17-25-200 53-36-20-25-200	 ^{2*}
	einteilig gekröpft 20 MOA	BH 14 BH 17 BH 20	40-36-14-25-200-20MOA 40-36-17-25-200-20MOA 40-36-20-25-200-20MOA	50-36-14-25-200-20MOA 50-36-17-25-200-20MOA 50-36-20-25-200-20MOA	53-36-14-25-200-20MOA 53-36-17-25-200-20MOA 53-36-20-25-200-20MOA	 ^{2*}
	zweiteilig	BH 14 BH 17 BH 20	41-36-14-00-200 41-36-17-00-200 41-36-20-00-200	51-36-14-00-200 51-36-17-00-200 51-36-20-00-200	57-36-14-00-200 57-36-17-00-200 57-36-20-00-200	 ^{1 & 2 & 3**}
	zweiteilig gekröpft	BH 14 BH 17 BH 20	41-36-14-25-200 41-36-17-25-200 41-36-20-25-200	51-36-14-25-200 51-36-17-25-200 51-36-20-25-200	57-36-14-25-200 57-36-17-25-200 57-36-20-25-200	 ^{1 & 2 & 3**}
	zweiteilig variabel	BH 20 BH 23 BH 26	44-36-20-00-200 44-36-23-00-200 44-36-26-00-200	54-36-20-00-200 54-36-23-00-200 54-36-26-00-200	56-36-20-00-200 56-36-23-00-200 56-36-26-00-200	 ^{1 & 2 & 3**}

RINGMONTAGE 40 MM

Ø 40

Ø 40	einteilig	BH 14 BH 17 BH 20	40-40-14-00-200 40-40-17-00-200 40-40-20-00-200	50-40-14-00-200 50-40-17-00-200 50-40-20-00-200	53-40-14-00-200 53-40-17-00-200 53-40-20-00-200	 ^{1*}
	einteilig 20 MOA	BH 14 BH 17 BH 20	40-40-14-00-200-20MOA 40-40-17-00-200-20MOA 40-40-20-00-200-20MOA	50-40-14-00-200-20MOA 50-40-17-00-200-20MOA 50-40-20-00-200-20MOA	53-40-14-00-200-20MOA 53-40-17-00-200-20MOA 53-40-20-00-200-20MOA	 ^{1*}
	einteilig gekröpft	BH 14 BH 17 BH 20	40-40-14-25-200 40-40-17-25-200 40-40-20-25-200	50-40-14-25-200 50-40-17-25-200 50-40-20-25-200	53-40-14-25-200 53-40-17-25-200 53-40-20-25-200	 ^{2*}
	einteilig gekröpft 20 MOA	BH 14 BH 17 BH 20	40-40-14-25-200-20MOA 40-40-17-25-200-20MOA 40-40-20-25-200-20MOA	50-40-14-25-200-20MOA 50-40-17-25-200-20MOA 50-40-20-25-200-20MOA	53-40-14-25-200-20MOA 53-40-17-25-200-20MOA 53-40-20-25-200-20MOA	 ^{2*}
	zweiteilig	BH 14 BH 17 BH 20	41-40-14-00-200 41-40-17-00-200 41-40-20-00-200	51-40-14-00-200 51-40-17-00-200 51-40-20-00-200	57-40-14-00-200 57-40-17-00-200 57-40-20-00-200	 ^{1 & 2 & 3**}
	zweiteilig gekröpft	BH 14 BH 17 BH 20	41-40-14-25-200 41-40-17-25-200 41-40-20-25-200	51-40-14-25-200 51-40-17-25-200 51-40-20-25-200	57-40-14-25-200 57-40-17-25-200 57-40-20-25-200	 ^{1 & 2 & 3**}
	zweiteilig variabel	BH 20 BH 23 BH 26	44-40-20-00-200 44-40-23-00-200 44-40-26-00-200	54-40-20-00-200 54-40-23-00-200 54-40-26-00-200	56-40-20-00-200 56-40-23-00-200 56-40-26-00-200	 ^{1 & 2 & 3**}

*Axialanschlag 5 mm (optional 3,8 mm) *Axial stop 5mm (optional 3,8 mm) | **Axialanschlag 3,8 mm (optional 5 mm) **Axial stop 3,8 mm (optional 5 mm)



FÜR WEAVER/PICATINNY (200)

¹ Auch passend für Merkel Helix / Steel Action / Sako S20 / Benelli Lupo / Anschütz 1782 / Haenel Jaeger EVO/NXT / CZ 600 / für Steyr MS | RMS Wild / ...
Länge Picatinny-Schiene ≥ 140 mm; Abstand der Klemmachsen 110 mm

¹ Also fits Merkel Helix / Steel Action / Sako S20 / Benelli Lupo / Anschütz 1782 / Haenel Jaeger EVO/NXT / CZ 600 / ...
length of Picatinny rail ≥ 140 mm; Distance between clamping axes 110 mm

² Auch passend für Strasser / Benelli Argo / ... / Länge Picatinny-Schiene ≥ 115 mm; Abstand der Klemmachsen 85 mm





² Also fits Strasser / Benelli Argo / ... / length of Picatinny rail ≥ 115 mm; Distance between clamping axes 85 mm

³ Auch passend für Länge Picatinny-Schiene ≥ 85 mm; Abstand der Klemmachsen 58 mm





³ Also fits length of Picatinny rail ≥ 85 mm; Distance between clamping axes 58 mm

	Bauhöhe	Zero	QD	FM	Ansicht QD
--	---------	------	----	----	------------

SWAROVSKI SR





SR	einteilig	BH 8 BH 20	40-SR-08-00-200 40-SR-20-00-200	50-SR-08-00-200 50-SR-20-00-200	53-SR-08-00-200 53-SR-20-00-200	
	einteilig gekröpft	BH 8	40-SR-08-25-200	50-SR-08-25-200	53-SR-08-25-200	
	zweiteilig	BH 8	41-SR-08-00-200	51-SR-08-00-200	57-SR-08-00-200	
	zweiteilig gekröpft	BH 8	41-SR-08-25-200	51-SR-08-25-200	57-SR-08-25-200	
	zweiteilig variabel	BH 15	44-SR-15-00-200	54-SR-15-00-200	56-SR-15-00-200	

ZEISS ZM/VM





VM	einteilig	BH 7 BH 20	40-VM-07-00-200 40-VM-20-00-200	50-VM-07-00-200 50-VM-20-00-200	53-VM-07-00-200 53-VM-20-00-200	
	einteilig gekröpft	BH 7	40-VM-07-25-200	50-VM-07-25-200	53-VM-07-25-200	
	zweiteilig	BH 7	41-VM-07-00-200	51-VM-07-00-200	57-VM-07-00-200	
	zweiteilig gekröpft	BH 7	41-VM-07-25-200	51-VM-07-25-200	57-VM-07-25-200	
	zweiteilig variabel	BH 15	44-VM-15-00-200	54-VM-15-00-200	56-VM-15-00-200	

	Bauhöhe	Zero	QD	FM	Ansicht QD
--	---------	------	----	----	------------





S&B Convex

SB	einteilig	BH 8	40-SB-08-00-200	50-SB-08-00-200	53-SB-08-00-200	
	einteilig gekröpft	BH 8	-	50-SB-08-25-200	-	
	zweiteilig	BH 8	-	51-SB-08-00-200	-	
	zweiteilig gekröpft	BH 8	-	51-SB-08-25-200	-	

LM Schiene

LM	einteilig	BH 15	40-LM-15-00-200	50-LM-15-00-200	53-LM-15-00-200	
	einteilig gekröpft	BH 15	40-LM-15-25-200	50-LM-15-25-200	53-LM-15-25-200	
	zweiteilig	BH 15	41-LM-15-00-200	51-LM-15-00-200	57-LM-15-00-200	
	zweiteilig gekröpft	BH 15	41-LM-15-25-200	51-LM-15-25-200	57-LM-15-25-200	
	zweiteilig variabel	BH 20	44-LM-20-00-200	54-LM-20-00-200	56-LM-20-00-200	

PICATINNY / PICATINNY Long

PT	einteilig	BH 20	40-PT-20-00-200	50-PT-20-00-200	53-PT-20-00-200	
	einteilig gekröpft	BH 20	40-PT-20-25-200	50-PT-20-25-200	53-PT-20-25-200	
	einteilig	BH 20	40-PT-20-60-200	50-PT-20-60-200	53-PT-20-60-200	
	zweiteilig variabel	BH 21	44-PT-21-00-200	54-PT-21-00-200	56-PT-21-00-200	

*Axialanschlag 5 mm (optional 3,8 mm) *Axial stop 5mm (optional 3,8 mm) | **Axialanschlag 3,8 mm (optional 5 mm) **Axial stop 3,8 mm (optional 5 mm)

FÜR WEAVER/PICATINNY (200)

¹ Auch passend für Merkel Helix / Steel Action / Sako S20 / Benelli Lupo / Anschütz 1782 / Haenel Jaeger EVO/NXT / CZ 600 / für Steyr MS | RMS Wild / ...
Länge Picatinnysschiene ≥ 140 mm; Abstand der Klemmachsen 110 mm

¹ Also fits Merkel Helix / Steel Action / Sako S20 / Benelli Lupo / Anschütz 1782 / Haenel Jaeger EVO/NXT / CZ 600 / ...
length of Picatinny rail ≥ 140 mm; Distance between clamping axes 110 mm

² Auch passend für Strasser / Benelli Argo / ... / Länge Picatinnysschiene ≥ 115 mm; Abstand der Klemmachsen 85 mm

² Also fits Strasser / Benelli Argo / ... / length of Picatinny rail ≥ 115 mm; Distance between clamping axes 85 mm

³ Auch passend für Länge Picatinnysschiene ≥ 85 mm; Abstand der Klemmachsen 58 mm





³ Also fits length of Picatinny rail ≥ 85 mm; Distance between clamping axes 58 mm

⁴ Nicht passend für Leica Tempus und Kahles Helia RD



⁴ Not for Leica Tempus and Kahles Helia RD

	Bauhöhe	Zero	QD	FM	Ansicht QD
--	---------	------	----	----	------------

DOCTER | NOBLEX | GECO | LEICA TEMPUS | VORTEX | BURRIS FAST FIRE | KAHLES HELIA RD

DS		Bauhöhe	Zero	QD	FM	Ansicht QD
	einteilig	BH 10	-	52-DS-10-00-200	-	 1 & 2 & 3**
	einteilig slight	BH 5	-	52-DS-05-00-200	-	 1 & 2 & 3** <small>Axialanschlag 5mm nicht möglich</small>
	einteilig slight long	BH 8	42-DS-08-00-200	-	-	 1 & 4*
	einteilig slight long gekröpft	BH 8	42-DS-08-25-200	-	-	 2 & 4*

AIMPOINT MICRO | HOLOSUN | GPO SPECTRA DOT SIG SAUER Romeo 4 / Romeo 5 / Romeo MSR

AM		Bauhöhe	Zero	QD	FM	Ansicht QD
	einteilig slight	BH 5	-	52-AM-05-00-200	-	 1 & 2 & 3** <small>Axialanschlag 5mm nicht möglich</small>
	einteilig slight long	BH 12	42-AM-12-00-200	-	-	 1*
	einteilig slight long gekröpft	BH 12	42-AM-12-25-200	-	-	 2*

AIMPOINT ACRO

AC		Bauhöhe	Zero	QD	FM	Ansicht QD
	Adapter	BH 7	-	24-AC-07	-	 1*

Passend nur in Verbindung mit 42-AM & 52-AM-... Only suitable in combination with 42-AM & 52-AM-...



AIMPOINT ACRO

AC		Bauhöhe	Zero	QD	FM	Ansicht QD
	einteilig slight long	BH 10	42-AC-10-00-200	-	-	 1*
	einteilig slight long gekröpft	BH 10	42-AC-10-25-200	-	-	 2*



*Axialanschlag 5 mm (optional 3,8 mm) *Axial stop 5mm (optional 3,8 mm) | **Axialanschlag 3,8 mm (optional 5 mm) **Axial stop 3,8 mm (optional 5 mm)

	Bauhöhe	Zero	QD	FM	Ansicht QD
--	---------	------	----	----	------------

PULSAR Apex | Digisight | Trail - YUKON Sightline N455S/N475S

PA		Bauhöhe	Zero	QD	FM	Ansicht QD
	einteilig	BH 10	40-PA-10-00-200	50-PA-10-00-200	-	 1*
	zweiteilig variabel	BH 17	44-PA-17-00-200	54-PA-17-00-200	-	 1 & 2 & 3**



PULSAR Trail 2 / LRF | Digisight Ultra N355/N450 LRF/N455 LRF

PA2		Bauhöhe	Zero	QD	FM	Ansicht QD
	einteilig	BH 10	40-PA2-10-00-200	50-PA2-10-00-200	-	 1*
	zweiteilig variabel	BH 17	44-PA2-17-00-200	54-PA2-17-00-200	-	 1 & 2 & 3**

PULSAR Thermion I+II/Pro/LRF | Thermion Duo DXP50/DXP55 - INFIRAY Tube TL35/TH35/TH35 SE/TH50/TS60 - LAHOUX Sight 35 - HIKMICRO Apex 4K Lite A40EL Stellar SH35/50/SQ35/50 | Stellar 2.0 SQ50 | Stellar 3.0 SH35/SH35L/SH50L/SQ35L/SQ50L/SX60L - NIGHT PEARL Marten TU420/TU430/TU450/TU650

GUIDE TU420/TU430/TU450/TU620/TU630/TU650 - THERMTEC Ares 335/360/635/660 | Ibex 335L | Oryx-L635/L650 - CONOTECH Night Arrow



PARD DS35 LRF | Nightstalker 4K | Pantera 480/640/640 Zoom - PIXFRA Pegasus/Pegasus Pro | Volans V850/V850 LRF - NOCPIX ACE H50R/H50/L35 | Bolt L35R/ P25R

TH		Bauhöhe	Zero	QD	FM	Ansicht QD
	einteilig	BH 24	40-TH-24-00-200	50-TH-24-00-200	-	 1*
	zweiteilig variabel	BH 26	44-TH-26-00-200	54-TH-26-00-200	-	 1 & 2 & 3**

PULSAR Digex N450/N455/C50 - INFIRAY Tube TH35 V2/TD50L/TH50 V2 - HIKMICRO Apex A50EL/A50T/A50TN/Pro A50P/Pro A50PL Stellar SX60L 3.0 - PARD DS35 - NOCPIX ACE S60R | ACE S60R | Nite D70R

DE		Bauhöhe	Zero	QD	FM	Ansicht QD
	einteilig	BH 27	40-DE-27-00-200	50-DE-27-00-200	-	 1*
	zweiteilig variabel	BH 29	44-DE-29-00-200	54-DE-29-00-200	-	 1 & 2 & 3**

PULSAR Talion XQ38/XG35 | Trail 3

TN		Bauhöhe	Zero	QD	FM	Ansicht QD
	einteilig	BH 10	40-TN-10-00-200	50-TN-10-00-200	-	 1* SHORT
	einteilig	BH 16	40-TN-16-00-200	50-TN-16-00-200	-	 1*
	zweiteilig variabel	BH 23	44-TN-23-00-200	54-TN-23-00-200	-	 1 & 2 & 3**

ATN Thor | Mars | X-Sight I + II

Ab Objektivdurchmesser 70 mm Art.Nr. 24-ATN-10 mitbestellen.

From an objective diameter of 70 mm, item no. order the 24-ATN-10 at the same time.

ATN		Bauhöhe	Zero	QD	FM	Ansicht QD
	einteilig	BH 12	-	50-ATN-12-00-200	-	 1*
	zweiteilig variabel	BH 18	-	54-ATN-18-00-200	-	 1 & 2 & 3**

FÜR WEAVER/PICATINNY (200)

¹ Auch passend für Merkel Helix / Steel Action / Sako S20 / Benelli Lupo / Anschütz 1782 / Haenel Jaeger EVO/NXT / CZ 600 / für Steyr MS | RMS Wild / ...
Länge Picatinnyschiene ≥ 140 mm; Abstand der Klemmachsen 110 mm

¹ Also fits Merkel Helix / Steel Action / Sako S20 / Benelli Lupo / Anschütz 1782 / Haenel Jaeger EVO/NXT / CZ 600 / ...
 length of Picatinny rail ≥ 140 mm; Distance between clamping axes 110 mm

² Auch passend für Strasser / Benelli Argo / ... / **Länge Picatinnyschiene ≥ 115 mm; Abstand der Klemmachsen 85 mm**



² Also fits Strasser / Benelli Argo / ... / length of Picatinny rail ≥ 115 mm; Distance between clamping axes 85 mm

³ Auch passend für Länge Picatinnyschiene ≥ 85 mm; **Abstand der Klemmachsen 58 mm**



³ Also fits length of Picatinny rail ≥ 85 mm; Distance between clamping axes 58 mm

	Bauhöhe	Zero	QD	FM	Ansicht QD
--	---------	------	----	----	------------



ATN4/5 Thor 4/LT | X-Sight 4K Pro/ LTV/4K INT

ATN4/5	Bauhöhe	Zero	QD	FM	Ansicht QD
einteilig	BH 24	40-ATN4-24-00-200	50-ATN4-24-00-200	-	
zweiteilig variabel	BH 26	44-ATN4-26-00-200	54-ATN4-26-00-200	-	

INFIRAY Xsight SH 50/SL 50 - LIEMKE Sperber 50/64 - LAHOUX Scope Elite 50

IRX	Bauhöhe	Zero	QD	FM	Ansicht QD
einteilig	BH 16	-	50-IRX-16-00-200	-	
zweiteilig variabel	BH 17	-	54-IRX-17-00-200	-	

INFIRAY Rico RH35/RH50/RL42/RS75* | Rico 2 S75R*/H75R* (Adapter 24-IRR-15 mitbestellen) | Geni GL35R/GL35/GH50/GH50R

IRR	Bauhöhe	Zero	QD	FM	Ansicht QD
einteilig	BH 10	40-IRR-10-00-200	50-IRR-10-00-200	-	
zweiteilig variabel	BH 17	44-IRR-17-00-200	54-IRR-17-00-200	-	

INFIRAY Saim SCP19/SCL35/SCT35/SCH50/SCT35 V2 - LIEMKE Sperber 19/25/35 NIGHT PEARL Fox 19 Hunt/35 Elite II/35 Hunt - NOCPIX Slim L35/H35

IRS	Bauhöhe	Zero	QD	FM	Ansicht QD
einteilig	BH 16	40-IRS-16-00-200	50-IRS-16-00-200	-	
zweiteilig variabel	BH 17	44-IRS-17-00-200	54-IRS-17-00-200	-	

INFIRAY Saim SCP 19/SCL 35/SCT 35/SCH 50/SCT 35 V2/CL42/CH50 V1/V2/W | Mate MAL25/38 | MAH50/R LIEMKE Sperber 19/25/35 - NIGHT PEARL Fox 19 Hunt/35 Elite II/35 Hunt - NOCPIX Mate H38R/H50R/Ultra | Slim L3/H35

IRM	Bauhöhe	Zero	QD	FM	Ansicht QD
einteilig	BH 9	40-IRM-09-00-200	50-IRM-09-00-200	-	

INFIRAY CML25

IRM	Bauhöhe	Zero	QD	FM	Ansicht QD
einteilig	BH 13	-	50-IRM-13-00-200	-	

	Bauhöhe	Zero	QD	FM	Ansicht QD
--	---------	------	----	----	------------



INFIRAY Tube TL25 SE/TL35 SE

SE26	Bauhöhe	Zero	QD	FM	Ansicht QD
einteilig	BH 34	40-SE26-30-00-200	-	-	
zweiteilig variabel	BH 36	44-SE26-36-00-200	-	-	



HIKMICRO Neos NE25/NH25L/NH35L - INFIRAY Tube TL25 SE/TL35 SE - Ø 30mm

SE30	Bauhöhe	Zero	QD	FM	Ansicht QD
einteilig	BH 27	40-SE30-27-00-200	-	-	
zweiteilig variabel	BH 33	44-SE30-33-00-200	-	-	



HIKMICRO Thunder TH25/TH35/TE19 PRO/TE25 PRO/TQ35 PRO/TQ50 PRO Panther PH35L/PH50L/PQ35L/PQ50L - Cheetah C32F-S/SL/SN/SNL

HMT	Bauhöhe	Zero	QD	FM	Ansicht QD
einteilig	BH 10	-	50-HMT-10-00-200	-	
einteilig	BH 18	40-HMT-18-00-200	50-HMT-18-00-200	-	
zweiteilig variabel	BH 20	44-HMT-20-00-200	54-HMT-20-00-200	-	



HIKMICRO Thunder 2.0 TE19/TE19 C/TE25/TH25 P/TH35 P//TH35 PC/TQ35/TQ35 C/TQ50/TQ50 C | Thunder Zoom 2.0 TH50 Z/TQ60 Z

HMT2	Bauhöhe	Zero	QD	FM	Ansicht QD
einteilig	BH 10	-	50-HMT2-10-00-200	-	
einteilig	BH 16	40-HMT2-16-00-200	-	-	
zweiteilig variabel	BH 20	44-HMT2-20-00-200	-	-	

INFIRAY Hybrid HYH35W/50W

HY	Bauhöhe	Zero	QD	FM	Ansicht QD
einteilig	BH 16	40-HY-16-00-200	-	-	
zweiteilig variabel	BH 19	44-HY-19-00-200	-	-	

INFIRAY TD70L

TD70	Bauhöhe	Zero	QD	FM	Ansicht QD
einteilig	BH 27	40-TD70-27-00-200	-	-	
zweiteilig variabel	BH 33	44-TD70-33-00-200	-	-	

FÜR WEAVER/PICATINNY (200)

¹ Auch passend für Merkel Helix / Steel Action / Sako S20 / Benelli Lupo / Anschütz 1782 / Haenel Jaeger EVO/NXT / CZ 600 / für Steyr MS | RMS Wild / ...
Länge Picatinnyschiene ≥ 140 mm; Abstand der Klemmachsen 110 mm
¹ Also fits Merkel Helix / Steel Action / Sako S20 / Benelli Lupo / Anschütz 1782 / Haenel Jaeger EVO/NXT / CZ 600 / ...
 length of Picatinny rail ≥ 140 mm; Distance between clamping axes 110 mm

² Auch passend für Strasser / Benelli Argo / ... / **Länge Picatinnyschiene ≥ 115 mm; Abstand der Klemmachsen 85 mm**
² Also fits Strasser / Benelli Argo / ... / length of Picatinny rail ≥ 115 mm; Distance between clamping axes 85 mm

³ Auch passend für Länge Picatinnyschiene ≥ 85 mm; **Abstand der Klemmachsen 58 mm**
³ Also fits length of Picatinny rail ≥ 85 mm; Distance between clamping axes 58 mm

	Bauhöhe	Zero	QD	FM	Ansicht QD
--	---------	------	----	----	------------

CONOTECH Avata 635/650/650LIIR

CTA	einteilig	BH 09	-	50-CTA-09-00-200	-	 ^{3*} SHORT
-----	-----------	-------	---	------------------	---	--

CONOTECH Polaris 335R/335RL/350R/350RL/635R/635RL/650R/650RL

CTP	einteilig	BH 17	40-CTP-17-00-200	-	-	^{1*}
	zweiteilig variabel	BH 20	44-CTP-20-00-200	-	-	^{1 & 2 & 3**}



DIYCON Visir

VI	einteilig	BH 08	-	50-VI-08-00-200	-	 ^{3*} SHORT
----	-----------	-------	---	-----------------	---	---



DIYCON Hydra II

H2	einteilig	BH 12	-	50-H2-12-00-200	-	 ^{3*} SHORT
----	-----------	-------	---	-----------------	---	--

DEDAL Hunter

DH	einteilig	BH 14	40-DH-14-00-200	50-DH-14-00-200	-	 ^{1*}
	zweiteilig variabel	BH 18	44-DH-18-00-200	54-DH-18-00-200	-	 ^{1 & 2 & 3**}

FORTUNA General

FG	einteilig	BH 18	-	50-FG-18-00-200	-	 ^{1*}
	einteilig 40 mm gekröpft	BH 18	-	50-FG-18-40-200	-	 ^{3*}

FORTUNA General One



FG1	einteilig	BH 14	40-FG1-14-00-200	50-FG1-14-00-200	-	 ^{1*}
	einteilig 40 mm gekröpft	BH 14	40-FG1-14-40-200	50-FG1-14-40-200	-	 ^{3*}

	Bauhöhe	Zero	QD	FM	Ansicht QD
--	---------	------	----	----	------------



GUIDE TS450

GT	einteilig	BH 17	-	50-GT-17-00-200	-	 ^{1*}
	zweiteilig variabel	BH 23	-	54-GT-23-00-200	-	 ^{1 & 2 & 3**}

PARD NV008P/LRF | SA 19/25/35/45 LRF - SYTONG HT60 | XM

PD	einteilig	BH 13	40-PD-13-00-200	50-PD-13-00-200	-	 ^{1*}
	zweiteilig variabel	BH 19	44-PD-19-00-200	54-PD-19-00-200	-	 ^{1 & 2 & 3**}

PARD NV008S/LRF | FT32 LRF

PD2	einteilig	BH 13	40-PD2-13-00-200	50-PD2-13-00-200	-	 ^{1*}
	zweiteilig variabel	BH 19	44-PD2-19-00-200	54-PD2-19-00-200	-	 ^{1 & 2 & 3**}

PIXFRA Chiron

PX	einteilig	BH 17	40-PX-17-00-200	-	-	^{1*}
	zweiteilig variabel	BH 20	44-PX-20-00-200	-	-	^{1 & 2 & 3**}

TVT Archer TSA

AR	zweiteilig variabel	BH 17	-	54-AR-17-00-200	-	 ^{1 & 2 & 3**}
----	---------------------	-------	---	-----------------	---	--

THERMTEC Vidar 335/335L/350/350L/360/360L/635/635L/650/650L/660/660L

TV	einteilig	BH 20	40-TV-20-00-200	-	-	 ^{1*}
	zweiteilig variabel	BH 22	44-TV-22-00-200	-	-	 ^{1 & 2 & 3**}

YUKON Photon

YP	zweiteilig variabel	BH 33	-	54-YP-33-00-200	-	 ^{1 & 2 & 3**}
----	---------------------	-------	---	-----------------	---	--

ZENTRON Q35/Q635/Q50/Q50R

ZT	einteilig	BH 16	40-ZT-16-00-200	-	-	^{1*}
----	-----------	-------	-----------------	---	---	---------------

*Axialanschlag 5 mm (optional 3,8 mm) *Axial stop 5mm (optional 3,8 mm) | **Axialanschlag 3,8 mm (optional 5 mm) **Axial stop 3,8 mm (optional 5 mm)

FÜR **WEAVER/PICATINNY** (200)

¹ Auch passend für Merkel Helix / Steel Action / Sako S20 / Benelli Lupo / Anschütz 1782 / Haenel Jaeger EVO/NXT / CZ 600 / für Steyr MS | RMS Wild / ...
Länge Picatinnysschiene ≥ 140 mm; Abstand der Klemmachsen 110 mm

¹ Also fits Merkel Helix / Steel Action / Sako S20 / Benelli Lupo / Anschütz 1782 / Haenel Jaeger EVO/NXT / CZ 600 / ...
 length of Picatinny rail ≥ 140 mm; Distance between clamping axes 110 mm

² Auch passend für Strasser / Benelli Argo / ... / **Länge Picatinnysschiene ≥ 115 mm; Abstand der Klemmachsen 85 mm**

² Also fits Strasser / Benelli Argo / ... / length of Picatinny rail ≥ 115 mm; Distance between clamping axes 85 mm

³ Auch passend für **Länge Picatinnysschiene ≥ 85 mm; Abstand der Klemmachsen 58 mm**

³ Also fits length of Picatinny rail ≥ 85 mm; Distance between clamping axes 58 mm

	Bauhöhe	Zero	QD	FM	Ansicht QD
--	---------	------	----	----	------------

HIKMICRO Thunder TE19C/TE19C 2.0/TH35C/TH35PC/TH35PC 2.0/TQ35 C/TQ35C 2.0
 TQ50C/TQ50C 2.0

HST	einteilig	BH 12	45-HST-12-00-200	55-HST-12-00-200	-	
------------	-----------	-------	------------------	------------------	---	---

DIPOL TFA

DST	einteilig	BH 12	45-DST-12-00-200	55-DST-12-00-200	-	
------------	-----------	-------	------------------	------------------	---	---

LIEMKE Merlin 35 | Luchs 1/2

LST	einteilig	BH 12	45-LST-12-00-200	55-LST-12-00-200	-	
------------	-----------	-------	------------------	------------------	---	--

NIGHT PEARL Seer 35/50

NST	einteilig	BH 12	45-NST-12-00-200	55-NST-12-00-200	-	
------------	-----------	-------	------------------	------------------	---	---

GUIDE SENSMART TA435/450 - **BURRIS** BTC35/50 - **JSA NIGHTLUX** TA435/450

GST	einteilig	BH 12	45-GST-12-00-200	55-GST-12-00-200	-	
------------	-----------	-------	------------------	------------------	---	---

GUN TEC Oberon

OST	einteilig	BH 12	45-OST-12-00-200	55-OST-12-00-200	-	
------------	-----------	-------	------------------	------------------	---	---

INFIRAY CML25 | **LIEMKE** Merlin 19/25

MST	einteilig	BH 12	45-MST-12-00-200	55-MST-12-00-200	-	
------------	-----------	-------	------------------	------------------	---	---

INFIRAY CL42/CH50 V1 & V2 | MAL 25/38 | MAH 50/R | **LIEMKE** Merlin 42/50
NOCPIX MATE H38R/H50R/ULTRA

SST	einteilig	BH 12	45-SST-12-00-200	55-SST-12-00-200	-	
------------	-----------	-------	------------------	------------------	---	---

*Axialanschlag 5 mm (optional 3,8 mm) *Axial stop 5mm (optional 3,8 mm) | **Axialanschlag 3,8 mm (optional 5 mm) **Axial stop 3,8 mm (optional 5 mm)



FÜR **BLASER**
 u. **SAUER 505**

FÜR BLASER | SAUER 505 (800)

	Bauhöhe	Zero	QD	FM	Ansicht QD
--	---------	------	----	----	------------

RINGMONTAGE 1"/26 MM

Ø 1"/26	einteilig	BH 14 BH 17 BH 20	40-26-14-00-800 40-26-17-00-800 40-26-20-00-800	50-26-14-00-800 50-26-17-00-800 50-26-20-00-800	53-26-14-00-800 53-26-17-00-800 53-26-20-00-800	
	einteilig 20 MOA	BH 14 BH 17 BH 20	40-26-14-00-800-20MOA 40-26-17-00-800-20MOA 40-26-20-00-800-20MOA	50-26-14-00-800-20MOA 50-26-17-00-800-20MOA 50-26-20-00-800-20MOA	53-26-14-00-800-20MOA 53-26-17-00-800-20MOA 53-26-20-00-800-20MOA	
	Ringe 20 mm nach vorne versetzt	BH 14 BH 17 BH 20	40-26-14-20-800 40-26-17-20-800 40-26-20-20-800	50-26-14-20-800 50-26-17-20-800 50-26-20-20-800	53-26-14-20-800 53-26-17-20-800 53-26-20-20-800	

RINGMONTAGE 30 MM

Ø 30	einteilig	BH 14 BH 17 BH 20 BH 23	40-30-14-00-800 40-30-17-00-800 40-30-20-00-800 40-30-23-00-800	50-30-14-00-800 50-30-17-00-800 50-30-20-00-800 50-30-23-00-800	53-30-14-00-800 53-30-17-00-800 53-30-20-00-800 53-30-23-00-800	
	einteilig 20 MOA	BH 14 BH 17 BH 20 BH 23	40-30-14-00-800-20MOA 40-30-17-00-800-20MOA 40-30-20-00-800-20MOA 40-30-23-00-800-20MOA	50-30-14-00-800-20MOA 50-30-17-00-800-20MOA 50-30-20-00-800-20MOA 50-30-23-00-800-20MOA	53-30-14-00-800-20MOA 53-30-17-00-800-20MOA 53-30-20-00-800-20MOA 53-30-23-00-800-20MOA	
	Ringe 20 mm nach vorne versetzt	BH 14 BH 17 BH 20 BH 23	40-30-14-20-800 40-30-17-20-800 40-30-20-20-800 40-30-23-20-800	50-30-14-20-800 50-30-17-20-800 50-30-20-20-800 50-30-23-20-800	53-30-14-20-800 53-30-17-20-800 53-30-20-20-800 53-30-23-20-800	

RINGMONTAGE 34 MM

Ø 34	einteilig	BH 14 BH 17 BH 20 BH 23	40-34-14-00-800 40-34-17-00-800 40-34-20-00-800 40-34-23-00-800	50-34-14-00-800 50-34-17-00-800 50-34-20-00-800 50-34-23-00-800	53-34-14-00-800 53-34-17-00-800 53-34-20-00-800 53-34-23-00-800	
	einteilig 20 MOA	BH 14 BH 17 BH 20 BH 23	40-34-14-00-800-20MOA 40-34-17-00-800-20MOA 40-34-20-00-800-20MOA 40-34-23-00-800-20MOA	50-34-14-00-800-20MOA 50-34-17-00-800-20MOA 50-34-20-00-800-20MOA 50-34-23-00-800-20MOA	53-34-14-00-800-20MOA 53-34-17-00-800-20MOA 53-34-20-00-800-20MOA 53-34-23-00-800-20MOA	
	Ringe 20 mm nach vorne versetzt	BH 14 BH 17 BH 20 BH 23	40-34-14-20-800 40-34-17-20-800 40-34-20-20-800 40-34-23-20-800	50-34-14-20-800 50-34-17-20-800 50-34-20-20-800 50-34-23-20-800	53-34-14-20-800 53-34-17-20-800 53-34-20-20-800 53-34-23-20-800	

RINGMONTAGE 35 MM

Ø 35	einteilig	BH 14 BH 17 BH 20	40-35-14-00-800 40-35-17-00-800 40-35-20-00-800	50-35-14-00-800 50-35-17-00-800 50-35-20-00-800	53-35-14-00-800 53-35-17-00-800 53-35-20-00-800	
	einteilig 20 MOA	BH 14 BH 17 BH 20	40-35-14-00-800-20MOA 40-35-17-00-800-20MOA 40-35-20-00-800-20MOA	50-35-14-00-800-20MOA 50-35-17-00-800-20MOA 50-35-20-00-800-20MOA	53-35-14-00-800-20MOA 53-35-17-00-800-20MOA 53-35-20-00-800-20MOA	
	Ringe 20 mm nach vorne versetzt	BH 14 BH 17 BH 20	40-35-14-20-800 40-35-17-20-800 40-35-20-20-800	50-35-14-20-800 50-35-17-20-800 50-35-20-20-800	53-35-14-20-800 53-35-17-20-800 53-35-20-20-800	

	Bauhöhe	Zero	QD	FM	Ansicht QD
--	---------	------	----	----	------------

RINGMONTAGE 36 MM

Ø 36	einteilig	BH 14 BH 17 BH 20	40-36-14-00-800 40-36-17-00-800 40-36-20-00-800	50-36-14-00-800 50-36-17-00-800 50-36-20-00-800	53-36-14-00-800 53-36-17-00-800 53-36-20-00-800	
	einteilig 20 MOA	BH 14 BH 17 BH 20	40-36-14-00-800-20MOA 40-36-17-00-800-20MOA 40-36-20-00-800-20MOA	50-36-14-00-800-20MOA 50-36-17-00-800-20MOA 50-36-20-00-800-20MOA	53-36-14-00-800-20MOA 53-36-17-00-800-20MOA 53-36-20-00-800-20MOA	
	Ringe 20 mm nach vorne versetzt	BH 14 BH 17 BH 20	40-36-14-20-800 40-36-17-20-800 40-36-20-20-800	50-36-14-20-800 50-36-17-20-800 50-36-20-20-800	53-36-14-20-800 53-36-17-20-800 53-36-20-20-800	

RINGMONTAGE 40 MM

Ø 40	einteilig	BH 14 BH 17 BH 20	40-40-14-00-800 40-40-17-00-800 40-40-20-00-800	50-40-14-00-800 50-40-17-00-800 50-40-20-00-800	53-40-14-00-800 53-40-17-00-800 53-40-20-00-800	
	einteilig 20 MOA	BH 14 BH 17 BH 20	40-40-14-00-800-20MOA 40-40-17-00-800-20MOA 40-40-20-00-800-20MOA	50-40-14-00-800-20MOA 50-40-17-00-800-20MOA 50-40-20-00-800-20MOA	53-40-14-00-800-20MOA 53-40-17-00-800-20MOA 53-40-20-00-800-20MOA	
	Ringe 20 mm nach vorne versetzt	BH 14 BH 17 BH 20	40-40-14-20-800 40-40-17-20-800 40-40-20-20-800	50-40-14-20-800 50-40-17-20-800 50-40-20-20-800	53-40-14-20-800 53-40-17-20-800 53-40-20-20-800	

SWAROVSKI SR (*Nicht für Z8i)

SR	einteilig	BH 10 BH 14 BH 20	40-SR-10-00-800* 40-SR-14-00-800 40-SR-20-00-800	50-SR-10-00-800 - 50-SR-20-00-800	53-SR-10-00-800 53-SR-14-00-800 53-SR-20-00-800	
----	-----------	-------------------------	--	---	---	--

ZEISS ZM/VM (*Nicht für V8)

VM	einteilig	BH 9 BH 14 BH 20	40-VM-09-00-800* 40-VM-14-00-800 40-VM-20-00-800	50-VM-09-00-800 - 50-VM-20-00-800	53-VM-09-00-800 53-VM-14-00-800 53-VM-20-00-800	
----	-----------	------------------------	--	---	---	--

S&B Convex

S&B	einteilig	BH 10	-	50-SB-10-00-800	-	
-----	-----------	-------	---	-----------------	---	--

LM Schiene

LM	einteilig	BH 15	40-LM-15-00-800	50-LM-15-00-800	53-LM-15-00-800	
----	-----------	-------	-----------------	-----------------	-----------------	--

PICATINNY / PICATINNY Long

PT	einteilig	BH 20	-	50-PT-20-00-800	-	
	einteilig	BH 20	40-PT-20-100-800	50-PT-20-100-800	53-PT-20-100-800	
	einteilig	BH 12	-	-	53-PT-12-00-800	

FÜR BLASER | SAUER 505 (800)

	Bauhöhe	Zero	QD	FM	Ansicht QD
--	---------	------	----	----	------------

DOCTER | NOBLEX | GECO | LEICA TEMPUS | VORTEX | BURRIS FAST FIRE | KAHLES HELIA RD

DS	einteilig slight long	BH 6	42-DS-08-00-800*	52-DS-06-00-800	-	
----	--------------------------	------	------------------	-----------------	---	---

(*Nicht für Leica Tempus und Kahles Helia RD)

AIMPOINT MICRO | HOLOSUN | GPO SPECTRA DOT | SIG SAUER Romeo 4 / Romeo 5 / Romeo MSR

AM	einteilig slight long	BH 6	42-AM-12-00-800	52-AM-06-00-800	-	
----	--------------------------	------	-----------------	-----------------	---	---

PICATINNY

PT	einteilig slight long	BH 12	-	52-PT-12-00-800	-	
----	--------------------------	-------	---	-----------------	---	---

AIMPOINT ACRO

AC	einteilig slight long	BH 10	42-AC-10-00-800	-	-	
----	--------------------------	-------	-----------------	---	---	---

FÜR BLASER | SAUER 505 (800)

	Bauhöhe	Zero	QD	FM	Ansicht QD
--	---------	------	----	----	------------

PULSAR Apex | Digsight | Trail - YUKON Sightline N455S/N475S

PA	einteilig	BH 10	40-PA-10-00-800	50-PA-10-00-800	-	
----	-----------	-------	-----------------	-----------------	---	---

PULSAR Trail 2 / LRF | Digsight Ultra N355/N450 LRF/N455 LRF

PA2	einteilig	BH 10	40-PA2-10-00-800	50-PA2-10-00-800	-	
-----	-----------	-------	------------------	------------------	---	---

FÜR BLASER | SAUER 505 (800)

	Bauhöhe	Zero	QD	FM	Ansicht QD
--	---------	------	----	----	------------

PULSAR Thermion I+II/Pro/LRF | Thermion Duo DXP50/DXP55 - INFIRAY Tube TL35/TH35/TH35 SE/TH50/TS60 - LAHOUX Sight 35 - HIKMICRO Apex 4K Lite A40EL Stellar SH35/50/SQ35/50 | Stellar 2.0 SQ50 | Stellar 3.0 SH35/SH35L/SH50L/SQ35L/SQ50L/SX60L - NIGHT PEARL Marten TU420/TU430/TU450/TU650 GUIDE TU420/TU430/TU450/TU620/TU630/TU650 - THERMTEC Ares 335/360/635/660 | Ibex 335L | Oryx-L635/L650 - CONOTECH Night Arrow PARD DS35 LRF | Nightstalker 4K | Pantera 480/640/640 Zoom - PIXFRA Pegasus/Pegasus Pro | Volans V850/V850 LRF - NOCPIX ACE H50R/H50/L35 | Bolt L35R/ P25R

TH	einteilig	BH 20	40-TH-20-00-800	50-TH-20-00-800	-	
----	-----------	-------	-----------------	-----------------	---	---

PULSAR Digex N450/N455/C50 - INFIRAY Tube TH35 V2/TD50L/TH50 V2 - HIKMICRO Apex A50EL/A50T/A50TN/Pro A50P/Pro A50PL Stellar SX60L 3.0 - PARD DS35 - NOCPIX ACE S60R | ACE S60R | Nite D70R

DE	einteilig	BH 23	40-DE-23-00-800	50-DE-23-00-800	-	
----	-----------	-------	-----------------	-----------------	---	---

PULSAR Talion XQ38/XG35 | Trail 3

TN	einteilig	BH 16	40-TN-16-00-800	50-TN-16-00-800	-	
----	-----------	-------	-----------------	-----------------	---	---

ATN Thor | Mars | X-Sight I + II

ATN	einteilig	BH 12	-	50-ATN-12-00-800*	-	
-----	-----------	-------	---	-------------------	---	--

*Ab Objektivdurchmesser 70 mm Art.Nr. **24-ATN-10** mitbestellen.
*From an objective diameter of 70 mm, item no. order the **24-ATN-10** at the same time.

ATN4/5 Thor 4/LT | X-Sight 4K Pro/ LTV/4K INT

ATN4/5	einteilig	BH 24	40-ATN4-24-00-800	50-ATN4-24-00-800	-	
--------	-----------	-------	-------------------	-------------------	---	---

CONOTECH Polaris 335R/335RL/350R/350RL/635R/635RL/650R/650RL

CTP	einteilig	BH 17	40-PX-17-00-800	-	-	
-----	-----------	-------	-----------------	---	---	--

INFIRAY Xsight SH 50/SL 50 - LIEMKE Sperber 50/64 - LAHOUX Scope Elite 50

IRX	einteilig	BH 16	-	50-IRX-16-00-800	-	
-----	-----------	-------	---	------------------	---	---

INFIRAY Rico RH35/RH50/RL42/RS75* | Rico 2 S75R*/H75R* (Adapter 24-IRR-15 mitbestellen) | Geni GL35R/GL35/GH50/GH50R

IRR	einteilig	BH 10	40-IRR-10-00-800	50-IRR-10-00-800	-	
-----	-----------	-------	------------------	------------------	---	---

INFIRAY Saim SCP19/SCL35/SCT35/SCH50/SCT35 V2 - LIEMKE Sperber 19/25/35 NIGHT PEARL Fox 19 Hunt/35 Elite II/35 Hunt - NOCPIX Slim L35/H35

IRS	einteilig	BH 16	40-IRS-16-00-800	50-IRS-16-00-800	-	
-----	-----------	-------	------------------	------------------	---	---

FÜR BLASER | SAUER 505 (800)

	Bauhöhe	Zero	QD	FM	Ansicht QD
--	---------	------	----	----	------------

INFIRAY Tube TL25 SE/TL35 SE

SE26	einteilig	BH 30	40-SE26-30-00-800	-	-	
-------------	-----------	-------	-------------------	---	---	---

HIKMICRO Neos NE25/NH25L/NH35L - INFIRAY Tube TL25 SE/TL35 SE - Ø 30mm

SE30	einteilig	BH 30	40-SE30-27-00-800	-	-	
-------------	-----------	-------	-------------------	---	---	---

INFIRAY Hybrid HYH35W/50W

HY	einteilig	BH 16	40-HY-16-00-800	-	-	
-----------	-----------	-------	-----------------	---	---	---

INFIRAY TD70L

TD70	einteilig	BH 27	40-TD70-27-00-800	-	-	
-------------	-----------	-------	-------------------	---	---	---

HIKMICRO Thunder TH25/TH35/TE19 PRO/TE25 PRO/TQ35 PRO/TQ50 PRO Panther PH35L/PH50L/PQ35L/PQ50L - Cheetah C32F-S/SL/SN/SNL

HMT	einteilig	BH 18	40-HMT-18-00-800	50-HMT-18-00-800	-	
------------	-----------	-------	------------------	------------------	---	---

HIKMICRO Thunder 2.0 TE19/TE19 C/TE25/TH25 P/TH35 P//TH35 PC/TQ35/TQ35 C/TQ50/TQ50 C | Thunder Zoom 2.0 TH50 Z/TQ60 Z

HMT2	einteilig	BH 18	40-HMT2-18-00-800	-	-	
-------------	-----------	-------	-------------------	---	---	---

DIYCON Visir

VI	einteilig	BH 18	40-VI-18-00-800	-	-	
-----------	-----------	-------	-----------------	---	---	---

DIYCON Hydra II

H2	einteilig	BH 18	40-H2-18-00-800	-	-	
-----------	-----------	-------	-----------------	---	---	---

DEDAL Hunter

DH	einteilig	BH 14	40-DH-14-00-800	50-DH-14-00-800	-	
-----------	-----------	-------	-----------------	-----------------	---	---

FORTUNA General

FG	einteilig	BH 18	40-FG-18-00-800	50-FG-18-00-800	-	
-----------	-----------	-------	-----------------	-----------------	---	---

	Bauhöhe	Zero	QD	FM	Ansicht QD
--	---------	------	----	----	------------

FORTUNA General One

FG1	einteilig	BH 14	40-FG1-14-00-800	50-FG1-14-00-800	-	
------------	-----------	-------	------------------	------------------	---	---

GSCI Wolfhound

GSWH	einteilig	BH 16	-	50-GSWH-16-00-800	-	
-------------	-----------	-------	---	-------------------	---	---

GUIDE TS450

GT	einteilig	BH 17	-	50-GT-17-00-800	-	
-----------	-----------	-------	---	-----------------	---	---

PARD NV008P/LRF | SA 19/25/35/45 LRF - SYTONG HT60 | XM

PD	einteilig	BH 13	40-PD-13-00-800	50-PD-13-00-800	-	
-----------	-----------	-------	-----------------	-----------------	---	---

PARD NV008S/LRF | FT32 LRF

PD2	einteilig	BH 13	40-PD2-13-00-800	50-PD2-13-00-800	-	
------------	-----------	-------	------------------	------------------	---	--

PIXFRA Chiron

PX	einteilig	BH 13	40-PX-17-00-800	-	-	
-----------	-----------	-------	-----------------	---	---	--

THERMTEC Vidar 335/335L/350/350L/360/360L/635/635L/650/650L/660/660L

TV	einteilig	BH 20	40-TV-20-00-800	-	-	
-----------	-----------	-------	-----------------	---	---	---

TVT Archer TSA

AR	einteilig	BH 13	-	50-AR-13-00-800	-	
-----------	-----------	-------	---	-----------------	---	---

YUKON Photon

YP	einteilig	BH 27	-	50-YP-27-00-800	-	
-----------	-----------	-------	---	-----------------	---	---

ZENTRON Q35/Q635/Q50/Q50R

ZT	einteilig	BH 16	40-ZT-16-00-800	-	-	
-----------	-----------	-------	-----------------	---	---	--

FÜR BLASER | SAUER 505 (800)

	Bauhöhe	Zero	QD	FM	Ansicht QD
--	---------	------	----	----	------------

HIKMICRO Thunder TE19C/TE19C 2.0/TH35C/TH35PC/TH35PC 2.0/TQ35 C/TQ35C 2.0
TQ50C/TQ50C 2.0

HST	einteilig	BH 15	45-HST-15-00-800	55-HST-15-00-800	-	
------------	-----------	-------	------------------	------------------	---	---

DIPOL TFA

DST	einteilig	BH 15	45-DST-15-00-800	55-DST-15-00-800	-	
------------	-----------	-------	------------------	------------------	---	---

LIEMKE Merlin 35 | Luchs 1/2

LST	einteilig	BH 15	45-LST-15-00-800	55-LST-15-00-800	-	
------------	-----------	-------	------------------	------------------	---	---

NIGHT PEARL Seer 35 & 50

NST	einteilig	BH 15	45-NST-15-00-800	55-NST-15-00-800	-	
------------	-----------	-------	------------------	------------------	---	---

GUIDE SENSMART TA435/450 - **BURRIS** BTC35/50 - **JSA NIGHTLUX** TA435/450

GST	einteilig	BH 15	45-GST-15-00-800	55-GST-15-00-800	-	
------------	-----------	-------	------------------	------------------	---	---

GUN TEC Oberon

OST	einteilig	BH 15	45-OST-15-00-800	55-OST-15-00-800	-	
------------	-----------	-------	------------------	------------------	---	---

INFIRAY CML25 | **LIEMKE** Merlin 19/25

MST	einteilig	BH 15	45-MST-15-00-800	55-MST-15-00-800	-	
------------	-----------	-------	------------------	------------------	---	---

INFIRAY CL42/CH50 V1 & V2 | MAL 25/38 | MAH 50/R | **LIEMKE** Merlin 42/50
NOPIX MATE H38R/H50R/ULTRA

SST	einteilig	BH 15	45-SST-15-00-800	55-SST-15-00-800	-	
------------	-----------	-------	------------------	------------------	---	---

*Abbildung ähnlich.



FÜR **BLASER R8 ULTIMATE X**

FÜR BLASER ULTIMATE X (850)

	Bauhöhe	Zero	QD	FM	Ansicht ZERO	
Ø 1"/26	RINGMONTAGE 1"/26 MM					
	einteilig	BH 26	40-26-26-00-850	-	-	
		BH 29	40-26-29-00-850	-	-	
		BH 32	40-26-32-00-850	-	-	

	Bauhöhe	Zero	QD	FM	Ansicht ZERO	
Ø 30	RINGMONTAGE 30 MM					
	einteilig	BH 26	40-30-26-00-850	-	-	
		BH 29	40-30-29-00-850	-	-	
		BH 32	40-30-32-00-850	-	-	
		BH 35	40-30-35-00-850	-	-	

	Bauhöhe	Zero	QD	FM	Ansicht ZERO	
Ø 34	RINGMONTAGE 34 MM					
	einteilig	BH 26	40-34-26-00-850	-	-	
		BH 29	40-34-29-00-850	-	-	
		BH 32	40-34-32-00-850	-	-	

	Bauhöhe	Zero	QD	FM	Ansicht ZERO	
Ø 35	RINGMONTAGE 35 MM					
	einteilig	BH 26	40-35-26-00-850	-	-	
		BH 29	40-35-29-00-850	-	-	
		BH 32	40-35-32-00-850	-	-	

	Bauhöhe	Zero	QD	FM	Ansicht ZERO	
Ø 36	RINGMONTAGE 36 MM					
	einteilig	BH 26	40-36-26-00-850	-	-	
		BH 29	40-36-29-00-850	-	-	
		BH 32	40-36-32-00-850	-	-	

	Bauhöhe	Zero	QD	FM	Ansicht ZERO
SR	SWAROVSKI SR				
	einteilig	BH 23	40-SR-23-00-850	-	-

	Bauhöhe	Zero	QD	FM	Ansicht ZERO
VM	ZEISS ZM/VM				
	einteilig	BH 21	40-VM-21-00-850	-	-

Ringdurchmesser	Ringunterteil	Max. Überstand Mittelrohr zu Montage	Max. Objektivdurchmesser	Artikelnummer
26 mm	3	1,5 mm	46 mm	40-26-26-00-850
26 mm	6	4,5 mm	52 mm	40-26-29-00-850
26 mm	9	7,5 mm	58 mm	40-26-32-00-850

30 mm	3	1,5 mm	50 mm	40-30-26-00-850
30 mm	6	4,5 mm	56 mm	40-30-29-00-850
30 mm	9	7,5 mm	62 mm	40-30-32-00-850
30 mm	12	10,5 mm	68 mm	40-30-35-00-850

34 mm	3	1,5 mm	54 mm	40-34-26-00-850
34 mm	6	4,5 mm	60 mm	40-34-29-00-850
34 mm	9	7,5 mm	66 mm	40-34-32-00-850
34 mm	12	10,5 mm	72 mm	40-34-35-00-850

35 mm	3	1,5 mm	56 mm	40-35-26-00-850
35 mm	6	4,5 mm	62 mm	40-35-29-00-850
35 mm	9	7,5 mm	68 mm	40-35-32-00-850

36 mm	3	1,5 mm	57 mm	40-36-26-00-850
36 mm	6	4,5 mm	63 mm	40-36-29-00-850
36 mm	9	7,5 mm	69 mm	40-36-32-00-850

40 mm	3	1,5 mm	60 mm	40-40-26-00-850
40 mm	6	4,5 mm	66 mm	40-40-29-00-850
40 mm	9	7,5 mm	72 mm	40-40-32-00-850

FÜR BLASER R8 ULTIMATE X





INN@GUN

IHR AUSSTATTER FÜR JAGD & OUTDOOR

INN@OPTIC

INN@STOCK

INN@GEAR



Optik/Beobachtung



Schäfte/Zubehör



Ausrüstung/Kleidung

Northern HUNTING

Waffen/Munition

Laserschießkino

CONOTECH

Blaser

uvm...

Nocpix



InfRay

MAUSER

LIEMKE

SWAROVSKI OPTIK

J.P. SAUER & SOHN ESTABLISHED 1751



ThermTec

STEINER



FOLIOSUN

DIYCON

SMARTCLIP



Deerhunter

Sytang

PULSAR

PRÄZISE JAGEN



BORESNAKE



SPARTAN PRECISION EQUIPMENT

HIKMICRO

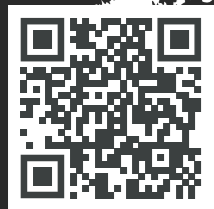

WWW.INNOGUN-SHOP.DE

INN@MOUNT
by INNOGUN



FÜR SAUER 404

FÜR SAUER 404 (650) Neues Modell Sauer 303 - SN: L....

	Bauhöhe	Zero	QD	FM	Ansicht QD
--	---------	------	----	----	------------

RINGMONTAGE 1"/26 MM

Ø 1"/26	einteilig	BH 14	40-26-14-00-650	50-26-14-00-650	53-26-14-00-650	
		BH 17	40-26-17-00-650	50-26-17-00-650	53-26-17-00-650	
		BH 20	40-26-20-00-650	50-26-20-00-650	53-26-20-00-650	

RINGMONTAGE 30 MM

Ø 30	einteilig	BH 14	40-30-14-00-650	50-30-14-00-650	53-30-14-00-650	
		BH 17	40-30-17-00-650	50-30-17-00-650	53-30-17-00-650	
		BH 20	40-30-20-00-650	50-30-20-00-650	53-30-20-00-650	
		BH 23	40-30-23-00-650	50-30-23-00-650	53-30-23-00-650	

RINGMONTAGE 34 MM

Ø 34	einteilig	BH 14	40-34-14-00-650	50-34-14-00-650	53-34-14-00-650	
		BH 17	40-34-17-00-650	50-34-17-00-650	53-34-17-00-650	
		BH 20	40-34-20-00-650	50-34-20-00-650	53-34-20-00-650	
		BH 23	40-34-23-00-650	50-34-23-00-650	53-34-23-00-650	

RINGMONTAGE 35 MM

Ø 35	einteilig	BH 14	40-35-14-00-650	50-35-14-00-650	53-35-14-00-650	
		BH 17	40-35-17-00-650	50-35-17-00-650	53-35-17-00-650	
		BH 20	40-35-20-00-650	50-35-20-00-650	53-35-20-00-650	

RINGMONTAGE 36 MM

Ø 36	einteilig	BH 14	40-36-14-00-650	50-36-14-00-650	53-36-14-00-650	
		BH 17	40-36-17-00-650	50-36-17-00-650	53-36-17-00-650	
		BH 20	40-36-20-00-650	50-36-20-00-650	53-36-20-00-650	

RINGMONTAGE 40 MM

Ø 40	einteilig	BH 14	40-40-14-00-650	50-40-14-00-650	53-40-14-00-650	
		BH 17	40-40-17-00-650	50-40-17-00-650	53-40-17-00-650	
		BH 20	40-40-20-00-650	50-40-20-00-650	53-40-20-00-650	

	Bauhöhe	Zero	QD	FM	Ansicht QD
--	---------	------	----	----	------------

SWAROVSKI SR

SR	einteilig	BH 9	40-SR-09-00-650	50-SR-09-00-650	53-SR-09-00-650	

ZEISS ZM/VM

VM	einteilig	BH 8	40-VM-08-00-650	50-VM-08-00-650	53-VM-08-00-650	



S&B Convex

S&B	einteilig	BH 9	-	50-SB-09-00-650	-	

LM Schiene





LM	einteilig	BH 15	40-LM-15-00-650	50-LM-15-00-650	53-LM-15-00-650	

PICATINNY / PICATINNY Long

PT	einteilig	BH 20	40-PT-20-00-650	50-PT-20-00-650	53-PT-20-00-650	
		BH 20	40-PT-20-70-650	50-PT-20-70-650	53-PT-20-70-650	

FÜR SAUER 404

FÜR SAUER 404 (650) Neues Modell Sauer 303 - SN: L....

	Bauhöhe	Zero	QD	FM	Ansicht QD	
DS	DOCTER NOBLEX GECO LEICA TEMPUS VORTEX BURRIS FAST FIRE KAHLES HELIA RD					
	einteilig slight long	BH 6	-	52-DS-06-00-650	-	
AM	AIMPOINT MICRO HOLOSUN GPO SPECTRA DOT SIG SAUER Romeo 4 / Romeo 5 / Romeo MSR					
	einteilig slight long	BH 6	-	52-AM-06-00-650	-	
PT	PICATINNY					
	einteilig slight long	BH 12	-	52-PT-12-00-650	-	
AC	AIMPOINT ACRO Slight Long					
	einteilig slight long	BH 10	42-AC-10-00-650	-	-	

FÜR SAUER 404 (650) Neues Modell Sauer 303 - SN: L....

	Bauhöhe	Zero	QD	FM	Ansicht QD	
PA	PULSAR Apex Digisight Trail - YUKON Sightline N455S/N475S					
	einteilig	BH 10	40-PA-10-00-650	50-PA-10-00-650	-	
PA2	PULSAR Trail 2 / LRF Digisight Ultra N355/N450 LRF/N455 LRF					
	einteilig	BH 10	40-PA2-10-00-650	50-PA2-10-00-650	-	
TH	PULSAR Thermion I/II/Pro/LRF Thermion Duo DXP50/DXP55 - INFIRAY Tube TL35/TH35/TH35 SE/TH50/TS60 - LAHOUX Sight 35 - HIKMICRO Apex 4K Lite A40EL Stellar SH35/50/SQ35/50 Stellar 2.0 SQ50 Stellar 3.0 SH35/SH35L/SH50L/SQ35L/SQ50L/SX60L - NIGHT PEARL Marten TU420/TU430/TU450/TU650 GUIDE TU420/TU430/TU450/TU620/TU630/TU650 - THERMTEC Ares 335/360/635/660 Ibex 335L Oryx-L635/L650 - CONOTECH Night Arrow PARD DS35 LRF Nightstalker 4K Pantera 480/640/640 Zoom - PIXFRA Pegasus/Pegasus Pro Volans V850/V850 LRF - NOCPIX ACE H50R/H50/L35 Bolt L35R/ P25R					
	einteilig	BH 24	40-TH-24-00-650	50-TH-24-00-650	-	
DE	PULSAR Digex N450/N455/C50 - INFIRAY Tube TH35 V2/TD50L/TH50 V2 - HIKMICRO Apex A50EL/A50T/A50TN/Pro A50P/Pro A50PL Stellar SX60L 3.0 - PARD DS35 - NOCPIX ACE S60R ACE S60R Nite D70R					
	einteilig	BH 27	40-DE-27-00-650	50-DE-27-00-650	-	
TN	PULSAR Talion XQ38/XG35 Trail 3					
	einteilig	BH 16	40-TN-16-00-650	50-TN-16-00-650	-	 *Abbildung ähnlich.
ATN	ATN Thor Mars X-Sight I + II					
	einteilig	BH 12	-	50-ATN-12-00-650*	-	
ATN4/5	ATN4/5 Thor 4/LT X-Sight 4K Pro/ LTV/4K INT					
	einteilig	BH 24	40-ATN4-24-00-650	50-ATN4-24-00-650	-	
IRX	INFIRAY Xsight SH 50/SL 50 - LIEMKE Sperber 50/64 - LAHOUX Scope Elite 50					
	einteilig	BH 16	-	50-IRX-16-00-650	-	

*Ab Objektivdurchmesser 70 mm Art.Nr. **24-ATN-10** mitbestellen.
*From an objective diameter of 70 mm, item no. order the **24-ATN-10** at the same time.



FÜR **SAUER 404** (650) Neues Modell Sauer 303 - SN: L....

	Bauhöhe	Zero	QD	FM	Ansicht QD
--	---------	------	----	----	------------

INFIRAY Rico RH35/RH50/RL42/RS75* | Rico 2 S75R*/H75R* *(Adapter 24-IRR-15 mitbestellen) | Geni GL35R/GL35/GH50/GH50R

IRR	einteilig	BH 10	40-IRR-10-00-650	50-IRR-10-00-650	-	
------------	-----------	-------	------------------	------------------	---	---

INFIRAY Saim SCP19/SCL35/SCT35/SCH50/SCT35 V2 - **LIEMKE** Sperber 19/25/35
NIGHT PEARL Fox 19 Hunt/35 Elite II/35 Hunt - **NOCPHX** Slim L35/H35

IRS	einteilig	BH 16	40-IRS-16-00-650	50-IRS-16-00-650	-	
------------	-----------	-------	------------------	------------------	---	---

*Abbildung ähnlich.

HIKMICRO Thunder TH25/TH35/TE19 PRO/TE25 PRO/TQ35 PRO/TQ50 PRO
Panther PH35L/PH50L/PQ35L/PQ50L - Cheetah C32F-S/SL/SN/SNL

HMT	einteilig	BH 18	40-HMT-18-00-650	50-HMT-18-00-650	-	
------------	-----------	-------	------------------	------------------	---	---

DEDAL Hunter

DH	einteilig	BH 14	-	50-DH-14-00-650	-	
-----------	-----------	-------	---	-----------------	---	---

GUIDE TS 450

GT	einteilig	BH 17	-	50-GT-17-00-650	-	
-----------	-----------	-------	---	-----------------	---	---

PARD NV008P/LRF | SA 19/25/35/45 LRF - **SYTONG** HT60 | XM

PD	einteilig	BH 13	40-PD-13-00-650	50-PD-13-00-650	-	
-----------	-----------	-------	-----------------	-----------------	---	---

PARD NV008S/LRF | FT32 LRF

PD2	einteilig	BH 13	40-PD2-13-00-650	50-PD2-13-00-650	-	
------------	-----------	-------	------------------	------------------	---	---

YUKON Photon

YP	einteilig	BH 27	-	50-YP-27-00-650	-	
-----------	-----------	-------	---	-----------------	---	---



FÜR **SAUER 404 (650)** Neues Modell Sauer 303 - SN: L...

	Bauhöhe	Zero	QD	FM	Ansicht QD
--	---------	------	----	----	------------

HIKMICRO Thunder TE19C/TE19C 2.0/TH35C/TH35PC/TH35PC 2.0/TQ35 C/TQ35C 2.0
TQ50C/TQ50C 2.0

HST	einteilig	BH 15	45-HST-15-00-650	55-HST-15-00-650	-	
------------	-----------	-------	------------------	------------------	---	---

DIPOL TFA

DST	einteilig	BH 15	45-DST-15-00-650	55-DST-15-00-650	-	
------------	-----------	-------	------------------	------------------	---	---

LIEMKE Merlin 35 | Luchs 1/2

LST	einteilig	BH 15	45-LST-15-00-650	55-LST-15-00-650	-	
------------	-----------	-------	------------------	------------------	---	---

NIGHT PEARL Seer 35 & 50

NST	einteilig	BH 15	45-NST-15-00-650	55-NST-15-00-650	-	
------------	-----------	-------	------------------	------------------	---	---

GUIDE SENSMART TA435/450 - **BURRIS** BTC35/50 - **JSA NIGHTLUX** TA435/450

GST	einteilig	BH 15	45-GST-15-00-650	55-GST-15-00-650	-	
------------	-----------	-------	------------------	------------------	---	---

GUN TEC Oberon

OST	einteilig	BH 15	45-OST-15-00-650	55-OST-15-00-650	-	
------------	-----------	-------	------------------	------------------	---	---

INFIRAY CML25 | **LIEMKE** Merlin 19/25

MST	einteilig	BH 15	45-MST-15-00-650	55-MST-15-00-650	-	
------------	-----------	-------	------------------	------------------	---	---

INFIRAY CL42/CH50 V1 & V2 | MAL 25/38 | MAH 50/R | **LIEMKE** Merlin 42/50
NOCPIX MATE H38R/H50R/ULTRA

SST	einteilig	BH 15	45-SST-15-00-650	55-SST-15-00-650	-	
------------	-----------	-------	------------------	------------------	---	---

*Abbildung ähnlich.

Weiteres Zubehör auf Seite 79. Further accessories on page 79.



FÜR **SAUER 303**

FÜR SAUER 303 (600)

Altes Modell Seriennummer: R....
Neues Modell Seriennummer L.... siehe ab Seite 12 / Sauer 404

	Bauhöhe	Zero	QD	FM	Ansicht QD
--	---------	------	----	----	------------

RINGMONTAGE 1"/26 MM

Ø 1"/26	einteilig	BH 14 BH 17 BH 20	-	50-26-14-00-600 50-26-17-00-600 50-26-20-00-600	-	
---------	-----------	-------------------------	---	---	---	---

RINGMONTAGE 30 MM

Ø 30	einteilig	BH 14 BH 17 BH 20 BH 23	-	50-30-14-00-600 50-30-17-00-600 50-30-20-00-600 50-30-23-00-600	-	
------	-----------	----------------------------------	---	--	---	---

RINGMONTAGE 34 MM

Ø 34	einteilig	BH 14 BH 17 BH 20 BH 23	-	50-34-14-00-600 50-34-17-00-600 50-34-20-00-600 50-34-23-00-600	-	
------	-----------	----------------------------------	---	--	---	---

RINGMONTAGE 35 MM

Ø 35	einteilig	BH 14 BH 17 BH 20	-	50-35-14-00-600 50-35-17-00-600 50-35-20-00-600	-	
------	-----------	-------------------------	---	---	---	---

RINGMONTAGE 36 MM

Ø 36	einteilig	BH 14 BH 17 BH 20	-	50-36-14-00-600 50-36-17-00-600 50-36-20-00-600	-	
------	-----------	-------------------------	---	---	---	---

RINGMONTAGE 40 MM

Ø 40	einteilig	BH 14 BH 17 BH 20	-	50-40-14-00-600 50-40-17-00-600 50-40-20-00-600	-	
------	-----------	-------------------------	---	---	---	---

	Bauhöhe	Zero	QD	FM	Ansicht QD
--	---------	------	----	----	------------

SWAROVSKI SR

SR	einteilig	BH 9	40-SR-09-00-600	50-SR-09-00-600	53-SR-09-00-600	
----	-----------	------	-----------------	-----------------	-----------------	---

ZEISS ZM/VM

VM	einteilig	BH 8	40-VM-08-00-600	50-VM-08-00-600	53-VM-08-00-600	
----	-----------	------	-----------------	-----------------	-----------------	---

S&B Convex

S&B	einteilig	BH 9	-	50-SB-09-00-600	-	
-----	-----------	------	---	-----------------	---	---

LM Schiene

LM	einteilig	BH 15	-	50-LM-15-00-600	-	
----	-----------	-------	---	-----------------	---	---

PICATINNY Long

PT	einteilig	BH 20	-	50-PT-20-70-600	-	 LONG
----	-----------	-------	---	-----------------	---	--

FÜR SAUER 303 (600)

Altes Modell Seriennummer: R...
Neues Modell Seriennummer L.... siehe ab Seite 12 / Sauer 404

	Bauhöhe	Zero	QD	FM	Ansicht QD
--	---------	------	----	----	------------

DOCTER | NOBLEX | GECO | LEICA TEMPUS | VORTEX | BURRIS FAST FIRE | KAHLES HELIA RD

DS	einteilig slight	BH 4	-	52-DS-04-00-600	-	
-----------	------------------	------	---	-----------------	---	---

AIMPOINT MICRO | HOLOSUN | GPO SPECTRA DOT | SIG SAUER Romeo 4 / Romeo 5 / Romeo MSR

AM	einteilig slight	BH 4	-	52-AM-04-00-600	-	
-----------	------------------	------	---	-----------------	---	---

FÜR SAUER 303 (600)

Altes Modell Seriennummer: R...
Neues Modell Seriennummer L.... siehe ab Seite 12 / Sauer 404

	Bauhöhe	Zero	QD	FM	Ansicht QD
--	---------	------	----	----	------------

PULSAR Apex | Digisight | Trail - **YUKON** Sightline N455S/N475S

PA	einteilig	BH 10	40-PA-10-00-600	50-PA-10-00-600	-	
-----------	-----------	-------	-----------------	-----------------	---	---

PULSAR Trail 2 / LRF | Digisight Ultra N355/N450 LRF/N455 LRF

PA2	einteilig	BH 10	40-PA2-10-00-600	50-PA2-10-00-600	-	
------------	-----------	-------	------------------	------------------	---	---

PULSAR Thermion I/II/Pro/LRF | Thermion Duo DXP50/DXP55 - **INFIRAY** Tube TL35/TH35/TH35 SE/TH50/TS60 - **LAHOUX** Sight 35 - **HIKMICRO** Apex 4K Lite A40EL Stellar SH35/50/SQ35/50 | Stellar 2.0 SQ50 | Stellar 3.0 SH35/SH35L/SH50L/SQ35L/SQ50L/SX60L - **NIGHT PEARL** Marten TU420/TU430/TU450/TU650 **GUIDE** TU420/TU430/TU450/TU620/TU630/TU650 - **THERMTEC** Ares 335/360/635/660 | Ibex 335L | Oryx-L635/L650 - **CONOTECH** Night Arrow **PARD** DS35 LRF | Nightstalker 4K | Pantera 480/640/640 Zoom - **PIXFRA** Pegasus/Pegasus Pro | Volans V850/V850 LRF - **NOCPPIX** ACE H50R/H50/L35 | Bolt L35R/ P25R

TH	einteilig	BH 24	40-TH-24-00-600	50-TH-24-00-600	-	
-----------	-----------	-------	-----------------	-----------------	---	---

PULSAR Digex N450/N455/C50 - **INFIRAY** Tube TH35 V2/TD50L/TH50 V2 - **HIKMICRO** Apex A50EL/A50T/A50TN/Pro A50P/Pro A50PL Stellar SX60L 3.0 - **PARD** DS35 - **NOCPPIX** ACE S60R | ACE S60R | Nite D70R

DE	einteilig	BH 27	40-DE-27-00-600	50-DE-27-00-600	-	
-----------	-----------	-------	-----------------	-----------------	---	---

ATN Thor | Mars | X-Sight I + II

ATN	einteilig	BH 12	-	50-ATN-12-00-600*	-	
------------	-----------	-------	---	-------------------	---	---

*Ab Objektivdurchmesser 70 mm Art.Nr. **24-ATN-10** mitbestellen.
*From an objective diameter of 70 mm, item no. order the **24-ATN-10** at the same time.

ATN4/5 Thor 4/LT | X-Sight 4K Pro/ LTV/4K INT

ATN4/5	einteilig	BH 24	40-ATN4-24-00-600	50-ATN4-24-00-600	-	
---------------	-----------	-------	-------------------	-------------------	---	---

YUKON Photon

YP	einteilig	BH 27	-	50-YP-27-00-600	-	
-----------	-----------	-------	---	-----------------	---	---

*Abbildung ähnlich.

FÜR **SAUER 303 (600)** Altes Modell Seriennummer: R....
Neues Modell Seriennummer L.... siehe ab Seite 12 / Sauer 404

	Bauhöhe	Zero	QD	FM	Ansicht QD
--	---------	------	----	----	------------

DEDAL Hunter

DH	einteilig	BH 14	-	50-DH-14-00-600	-	
----	-----------	-------	---	-----------------	---	---

PARD NV008P/LRF | SA 19/25/35/45 LRF - **SYTONG** HT60 | XM

PD	einteilig	BH 13	-	50-PD-13-00-600	-	
----	-----------	-------	---	-----------------	---	---

PARD NV008S/LRF | FT32 LRF

PD2	einteilig	BH 13	40-PD2-13-00-600	50-PD2-13-00-600	-	
-----	-----------	-------	------------------	------------------	---	---

GUIDE TS 450

GT	einteilig	BH 17	-	50-GT-17-00-600	-	
----	-----------	-------	---	-----------------	---	---

INFIRAY Rico RH35/RH50/RL42/RS75* | Rico 2 S75R*/H75R* *(Adapter 24-IRR-15 mitbestellen) | Geni GL35R/GL35/GH50/GH50R

IRR	einteilig	BH 10	40-IRR-10-00-600	-	-	
-----	-----------	-------	------------------	---	---	---

INFIRAY Saim SCP19/SCL35/SCT35/SCH50/SCT35 V2 - **LIEMKE** Sperber 19/25/35
NIGHT PEARL Fox 19 Hunt/35 Elite II/35 Hunt - **NOCPIX** Slim L35/H35

IRS	einteilig	BH 16	40-IRS-16-00-600	50-IRS-16-00-600	-	
-----	-----------	-------	------------------	------------------	---	---

*Abbildung ähnlich.

HIKMICRO Thunder TH25/TH35/TE19 PRO/TE25 PRO/TQ35 PRO/TQ50 PRO
Panther PH35L/PH50L/PQ35L/PQ50L - Cheetah C32F-S/SL/SN/SNL

HMT	einteilig	BH 18	40-HMT-18-00-600	50-HMT-18-00-600	-	
-----	-----------	-------	------------------	------------------	---	---



FÜR **TIKKA T3/T3x**

FÜR TIKKA T3 / T3x (400)

	Bauhöhe	Zero	QD	FM	Ansicht QD
--	---------	------	----	----	------------

RINGMONTAGE 1"/26 MM

Ø 1"/26	einteilig	BH 16	40-26-16-00-400	50-26-16-00-400	53-26-16-00-400	
		BH 19	40-26-19-00-400	50-26-19-00-400	53-26-19-00-400	
		BH 22	40-26-22-00-400	50-26-22-00-400	53-26-22-00-400	

RINGMONTAGE 30 MM

Ø 30	einteilig	BH 16	40-30-16-00-400	50-30-16-00-400	53-30-16-00-400	
		BH 19	40-30-19-00-400	50-30-19-00-400	53-30-19-00-400	
		BH 22	40-30-22-00-400	50-30-22-00-400	53-30-22-00-400	
		BH 25	40-30-25-00-400	50-30-25-00-400	53-30-25-00-400	

RINGMONTAGE 34 MM

Ø 34	einteilig	BH 16	40-34-16-00-400	50-34-16-00-400	53-34-16-00-400	
		BH 19	40-34-19-00-400	50-34-19-00-400	53-34-19-00-400	
		BH 22	40-34-22-00-400	50-34-22-00-400	53-34-22-00-400	
		BH 25	40-34-25-00-400	50-34-25-00-400	53-34-25-00-400	

RINGMONTAGE 35 MM

Ø 35	einteilig	BH 16	40-35-16-00-400	50-35-16-00-400	53-35-16-00-400	
		BH 19	40-35-19-00-400	50-35-19-00-400	53-35-19-00-400	
		BH 22	40-35-22-00-400	50-35-22-00-400	53-35-22-00-400	

RINGMONTAGE 36 MM

Ø 36	einteilig	BH 16	40-36-16-00-400	50-36-16-00-400	53-36-16-00-400	
		BH 19	40-36-19-00-400	50-36-19-00-400	53-36-19-00-400	
		BH 22	40-36-22-00-400	50-36-22-00-400	53-36-22-00-400	

RINGMONTAGE 40 MM

Ø 40	einteilig	BH 16	40-40-16-00-400	50-40-16-00-400	53-40-16-00-400	
		BH 19	40-40-19-00-400	50-40-19-00-400	53-40-19-00-400	
		BH 22	40-40-22-00-400	50-40-22-00-400	53-40-22-00-400	

	Bauhöhe	Zero	QD	FM	Ansicht QD
--	---------	------	----	----	------------

SWAROVSKI SR

SR	einteilig	BH 10	40-SR-10-00-400	50-SR-10-00-400	53-SR-10-00-400	

ZEISS ZM/VM

VM	einteilig	BH 9	40-VM-09-00-400	50-VM-09-00-400	53-VM-09-00-400	



S&B Convex

S&B	einteilig	BH 10	-	50-SB-10-00-400	-	

LM Schiene

LM	einteilig	BH 17	40-LM-17-00-400	50-LM-17-00-400	53-LM-17-00-400	

PICATINNY / PICATINNY Long

PT	einteilig	BH 20	-	50-PT-20-00-400	-	
		BH 20	-	50-PT-20-60-400	-	

*Abbildung ähnlich.

FÜR TIKKA T3/T3x

FÜR TIKKA T3 / T3X (400)

	Bauhöhe	Zero	QD	FM	Ansicht QD
--	---------	------	----	----	------------

DOCTER | NOBLEX | GECO | LEICA TEMPUS | VORTEX | BURRIS FAST FIRE | KAHLES HELIA RD

DS	einteilig slight	BH 5	-	52-DS-05-00-400	-	
----	---------------------	------	---	-----------------	---	---

AIMPOINT MICRO | HOLOSUN | GPO SPECTRA DOT | SIG SAUER Romeo 4 / Romeo 5 / Romeo MSR

AM	einteilig slight	BH 5	-	52-AM-05-00-400	-	
----	---------------------	------	---	-----------------	---	---

FÜR TIKKA T3 / T3X (400)

	Bauhöhe	Zero	QD	FM	Ansicht QD
--	---------	------	----	----	------------

PULSAR Apex | Digisight | Trail - YUKON Sightline N455S/N475S

PA	einteilig	BH 10	40-PA-10-00-400	50-PA-10-00-400	-	
----	-----------	-------	-----------------	-----------------	---	---

PULSAR Trail 2 / LRF | Digisight Ultra N355/N450 LRF/N455 LRF

PA2	einteilig	BH 10	40-PA2-10-00-400	50-PA2-10-00-400	-	
-----	-----------	-------	------------------	------------------	---	---

PULSAR Thermion I+II/Pro/LRF | Thermion Duo DXP50/DXP55 - INFIRAY Tube TL35/TH35/TH35 SE/TH50/TS60 - LAHOUX Sight 35 - HIKMICRO Apex 4K Lite A40EL Stellar SH35/50/SQ35/50 | Stellar 2.0 SQ50 | Stellar 3.0 SH35/SH35L/SH50L/SQ35L/SQ50L/SX60L - NIGHT PEARL Marten TU420/TU430/TU450/TU650 GUIDE TU420/TU430/TU450/TU620/TU630/TU650 - THERMTEC Ares 335/360/635/660 | Ibex 335L | Oryx-L635/L650 - CONOTECH Night Arrow PARD DS35 LRF | Nightstalker 4K | Pantera 480/640/640 Zoom - PIXFRA Pegasus/Pegasus Pro | Volans V850/V850 LRF - NOCPIX ACE H50R/H50/L35 | Bolt L35R/ P25R

TH	einteilig	BH 24	40-TH-24-00-400	50-TH-24-00-400	-	
----	-----------	-------	-----------------	-----------------	---	---

PULSAR Digex N450/N455/C50 - INFIRAY Tube TH35 V2/TD50L/TH50 V2 - HIKMICRO Apex A50EL/A50T/A50TN/Pro A50P/Pro A50PL Stellar SX60L 3.0 - PARD DS35 - NOCPIX ACE S60R | ACE S60R | Nite D70R

DE	einteilig	BH 27	40-DE-27-00-400	50-DE-27-00-400	-	
----	-----------	-------	-----------------	-----------------	---	---

ATN Thor | Mars | X-Sight I + II

ATN	einteilig	BH 12	-	50-ATN-12-00-400*	-	
-----	-----------	-------	---	-------------------	---	---

*Ab Objektivdurchmesser 70 mm Art.Nr. 24-ATN-10 mitbestellen.
*From an objective diameter of 70 mm, item no. order the 24-ATN-10 at the same time.

ATN4/5 Thor 4/LT | X-Sight 4K Pro/ LTV/4K INT

ATN4/5	einteilig	BH 24	40-ATN4-24-00-400	50-ATN4-24-00-400	-	
--------	-----------	-------	-------------------	-------------------	---	---

YUKON Photon

YP	einteilig	BH 27	-	50-YP-27-00-400	-	
----	-----------	-------	---	-----------------	---	---

DEDAL Hunter

DH	einteilig	BH 14	-	50-DH-14-00-400	-	
----	-----------	-------	---	-----------------	---	---



FÜR TIKKA T3 / T3X (400)

	Bauhöhe	Zero	QD	FM	Ansicht QD
--	---------	------	----	----	------------

TVT Archer TSA

AR	einteilig	BH 13	-	50-AR-13-00-400	-	
-----------	-----------	-------	---	-----------------	---	---

PARD NV008P/LRF | SA 19/25/35/45 LRF - SYTONG HT60 | XM

PD	einteilig	BH 13	40-PD-13-00-400	50-PD-13-00-400	-	
-----------	-----------	-------	-----------------	-----------------	---	---

PARD NV008S/LRF | FT32 LRF

PD2	einteilig	BH 13	40-PD2-13-00-400	50-PD2-13-00-400	-	
------------	-----------	-------	------------------	------------------	---	---

GUIDE TS 450

GT	einteilig	BH 17	-	50-GT-17-00-400	-	
-----------	-----------	-------	---	-----------------	---	---

INFIRAY Rico RH35/RH50/RL42/RS75* | Rico 2 S75R*/H75R* (Adapter 24-IRR-15 mitbestellen) | Geni GL35R/GL35/GH50/GH50R

IRR	einteilig	BH 10	40-IRR-10-00-400	50-IRR-10-00-400	-	
------------	-----------	-------	------------------	------------------	---	---

INFIRAY Saim SCP19/SCL35/SCT35/SCH50/SCT35 V2 - LIEMKE Sperber 19/25/35 NIGHT PEARL Fox 19 Hunt/35 Elite II/35 Hunt - NOCPIX Slim L35/H35

IRS	einteilig	BH 16	40-IRS-16-00-400	50-IRS-16-00-400	-	
------------	-----------	-------	------------------	------------------	---	---

*Abbildung ähnlich.

HIKMICRO Thunder TH25/TH35/TE19 PRO/TE25 PRO/TQ35 PRO/TQ50 PRO Panther PH35L/PH50L/PQ35L/PQ50L - Cheetah C32F-S/SL/SN/SNL

HMT	einteilig	BH 18	40-HMT-18-00-400	50-HMT-18-00-400	-	
------------	-----------	-------	------------------	------------------	---	---



FÜR **CZ 550/557**

FÜR **CZ 550/557** (520)

	Bauhöhe	Zero	QD	FM	Ansicht QD
--	---------	------	----	----	------------

RINGMONTAGE 1"/26 MM

Ø 1"/26	einteilig	BH 16	40-26-16-00-520	50-26-16-00-520	53-26-16-00-520	
		BH 19	40-26-19-00-520	50-26-19-00-520	53-26-19-00-520	
		BH 22	40-26-22-00-520	50-26-22-00-520	53-26-22-00-520	

RINGMONTAGE 30 MM

Ø 30	einteilig	BH 16	40-30-16-00-520	50-30-16-00-520	53-30-16-00-520	
		BH 19	40-30-19-00-520	50-30-19-00-520	53-30-19-00-520	
		BH 22	40-30-22-00-520	50-30-22-00-520	53-30-22-00-520	
		BH 25	40-30-25-00-520	50-30-25-00-520	53-30-25-00-520	

RINGMONTAGE 34 MM

Ø 34	einteilig	BH 16	40-34-16-00-520	50-34-16-00-520	53-34-16-00-520	
		BH 19	40-34-19-00-520	50-34-19-00-520	53-34-19-00-520	
		BH 22	40-34-22-00-520	50-34-22-00-520	53-34-22-00-520	
		BH 25	40-34-25-00-520	50-34-25-00-520	53-34-25-00-520	

RINGMONTAGE 35 MM

Ø 35	einteilig	BH 16	40-35-16-00-520	50-35-16-00-520	53-35-16-00-520	
		BH 19	40-35-19-00-520	50-35-19-00-520	53-35-19-00-520	
		BH 22	40-35-22-00-520	50-35-22-00-520	53-35-22-00-520	

RINGMONTAGE 36 MM

Ø 36	einteilig	BH 16	40-36-16-00-520	50-36-16-00-520	53-36-16-00-520	
		BH 19	40-36-19-00-520	50-36-19-00-520	53-36-19-00-520	
		BH 22	40-36-22-00-520	50-36-22-00-520	53-36-22-00-520	

RINGMONTAGE 40 MM

Ø 40	einteilig	BH 16	40-40-16-00-520	50-40-16-00-520	53-40-16-00-520	
		BH 19	40-40-19-00-520	50-40-19-00-520	53-40-19-00-520	
		BH 22	40-40-22-00-520	50-40-22-00-520	53-40-22-00-520	

	Bauhöhe	Zero	QD	FM	Ansicht QD
--	---------	------	----	----	------------

SWAROVSKI SR

SR	einteilig	BH 10	-	50-SR-10-00-520	-	

ZEISS ZM/VM

VM	einteilig	BH 9	-	50-VM-09-00-520	-	

S&B Convex

S&B	einteilig	BH 10	-	50-SB-10-00-520	-	

LM Schiene

LM	einteilig	BH 17	40-LM-17-00-520	50-LM-17-00-520	53-LM-17-00-520	

PICATINNY / PICATINNY Long

PT	einteilig	BH 20	-	50-PT-20-00-520	-	
		BH 20	-	50-PT-20-60-520	-	

*Abbildung ähnlich.

FÜR CZ 550/557

FÜR CZ 550/557 (520)

	Bauhöhe	Zero	QD	FM	Ansicht QD
--	---------	------	----	----	------------

PULSAR Apex | Digisight | Trail - YUKON Sightline N455S/N475S

PA	einteilig	BH 10	40-PA-10-00-520	50-PA-10-00-520	-	
----	-----------	-------	-----------------	-----------------	---	--

PULSAR Trail 2 / LRF | Digisight Ultra N355/N450 LRF/N455 LRF

PA2	einteilig	BH 10	40-PA2-10-00-520	50-PA2-10-00-520	-	
-----	-----------	-------	------------------	------------------	---	--

PULSAR Thermion I+II/Pro/LRF | Thermion Duo DXP50/DXP55 - **INFIRAY** Tube TL35/TH35/TH35 SE/TH50/TS60 - **LAHOUX** Sight 35 - **HIKMICRO** Alpex 4K Lite A40EL Stellar SH35/50/SQ35/50 | Stellar 2.0 SQ50 | Stellar 3.0 SH35/SH35L/SH50L/SQ35L/SQ50L/SX60L - **NIGHT PEARL** Marten TU420/TU430/TU450/TU650 **GUIDE** TU420/TU430/TU450/TU620/TU630/TU650 - **THERMTEC** Ares 335/360/635/660 | Ibex 335L | Oryx-L635/L650 - **CONOTECH** Night Arrow **PARD** DS35 LRF | Nightstalker 4K | Pantera 480/640/640 Zoom - **PIXFRA** Pegasus/Pegasus Pro | Volans V850/V850 LRF - **NOCPIX** ACE H50R/H50/L35 | Bolt L35R/ P25R

TH	einteilig	BH 24	40-TH-24-00-520	50-TH-24-00-520	-	
----	-----------	-------	-----------------	-----------------	---	--

PULSAR Digex N450/N455/C50 - **INFIRAY** Tube TH35 V2/TD50L/TH50 V2 - **HIKMICRO** Alpex A50EL/A50T/A50TN/Pro A50P/Pro A50PL Stellar SX60L 3.0 - **PARD** DS35 - **NOCPIX** ACE S60R | ACE S60R | Nite D70R

DE	einteilig	BH 27	40-DE-27-00-520	50-DE-27-00-520	-	
----	-----------	-------	-----------------	-----------------	---	--

ATN Thor | Mars | X-Sight I + II

ATN	einteilig	BH 12	-	50-ATN-12-00-520*	-	
-----	-----------	-------	---	-------------------	---	--

*Ab Objektivdurchmesser 70 mm Art.Nr. **24-ATN-10** mitbestellen.
*From an objective diameter of 70 mm, item no. order the **24-ATN-10** at the same time.

ATN4/5 Thor 4/LT | X-Sight 4K Pro/ LTV/4K INT

ATN4/5	einteilig	BH 24	40-ATN4-24-00-520	50-ATN4-24-00-520	-	
--------	-----------	-------	-------------------	-------------------	---	--

YUKON Photon

YP	einteilig	BH 27	-	50-YP-27-00-520	-	
----	-----------	-------	---	-----------------	---	--

*Abbildung ähnlich.



FÜR **CZ 550/557** (520)

	Bauhöhe	Zero	QD	FM	Ansicht QD
--	---------	------	----	----	------------

PARD NV008P/LRF | SA 19/25/35/45 LRF - **SYTONG HT60** | XM

PD	einteilig	BH 13	-	50-PD-13-00-520	-	
----	-----------	-------	---	-----------------	---	---

PARD NV008S/LRF | FT32 LRF

PD2	einteilig	BH 13	40-PD2-13-00-520	50-PD2-13-00-520	-	
-----	-----------	-------	------------------	------------------	---	---

GUIDE TS 450

GT	einteilig	BH 17	-	50-GT-17-00-520	-	
----	-----------	-------	---	-----------------	---	--

INFIRAY Rico RH35/RH50/RL42/RS75* | Rico 2 S75R*/H75R* *(Adapter 24-IRR-15 mitbestellen) | Geni GL35R/GL35/GH50/GH50R

IRR	einteilig	BH 10	40-IRR-10-00-520	50-IRR-10-00-520	-	
-----	-----------	-------	------------------	------------------	---	---

INFIRAY Saim SCP19/SCL35/SCT35/SCH50/SCT35 V2 - **LIEMKE Sperber 19/25/35**
NIGHT PEARL Fox 19 Hunt/35 Elite II/35 Hunt - **NOCPPIX Slim L35/H35**

IRS	einteilig	BH 16	40-IRS-16-00-520	50-IRS-16-00-520	-	
-----	-----------	-------	------------------	------------------	---	---

*Abbildung ähnlich.

HIKMICRO Thunder TH25/TH35/TE19 PRO/TE25 PRO/TQ35 PRO/TQ50 PRO
Panther PH35L/PH50L/PQ35L/PQ50L - **Cheetah C32F-S/SL/SN/SNL**

HMT	einteilig	BH 18	40-HMT-18-00-520	50-HMT-18-00-520	-	
-----	-----------	-------	------------------	------------------	---	---



FÜR **MERKEL**

FÜR MERKEL (900)

	Bauhöhe	Zero	QD	FM	Ansicht QD
--	---------	------	----	----	------------

RINGMONTAGE 1"/26 MM

Ø 1"/26	einteilig	BH 13	-	50-26-13-00-900 50-26-16-00-900 50-26-19-00-900	-	
		BH 16 BH 19				

RINGMONTAGE 30 MM

Ø 30	einteilig	BH 13	-	50-30-13-00-900 50-30-16-00-900 50-30-19-00-900 50-30-22-00-900	-	
		BH 16 BH 19 BH 22				

RINGMONTAGE 34 MM

Ø 34	einteilig	BH 13	-	50-34-13-00-900 50-34-16-00-900 50-34-19-00-900 50-34-22-00-900	-	
		BH 16 BH 19 BH 22				

RINGMONTAGE 35 MM

Ø 35	einteilig	BH 13	-	50-35-13-00-900 50-35-16-00-900 50-35-19-00-900	-	
		BH 16 BH 19				

RINGMONTAGE 36 MM

Ø 36	einteilig	BH 13	-	50-36-13-00-900 50-36-16-00-900 50-36-19-00-900	-	
		BH 16 BH 19				

RINGMONTAGE 40 MM

Ø 40	einteilig	BH 13	-	50-40-13-00-900 50-40-16-00-900 50-40-19-00-900	-	
		BH 16 BH 19				

	Bauhöhe	Zero	QD	FM	Ansicht QD
--	---------	------	----	----	------------

SWAROVSKI SR

SR	einteilig	BH 10	-	50-SR-10-00-900	-	

ZEISS ZM/VM

VM	einteilig	BH 7	-	50-VM-07-00-900	-	

LM Schiene

LM	einteilig	BH 14	-	50-LM-14-00-900	-	

PICATINNY / PICATINNY Long

PT	einteilig	BH 20	-	50-PT-20-110-900	-	

FÜR MERKEL (900)

	Bauhöhe	Zero	QD	FM	Ansicht QD
--	---------	------	----	----	------------

DOCTER | NOBLEX | GECO | LEICA TEMPUS | VORTEX | BURRIS FAST FIRE | KAHLES HELIA RD

DS	einteilig slight long	BH 6	-	52-DS-06-00-900	-	
----	--------------------------	------	---	-----------------	---	---

AIMPOINT MICRO | HOLOSUN | GPO SPECTRA DOT | SIG SAUER Romeo 4 / Romeo 5 / Romeo MSR

AM	einteilig slight long	BH 6	-	52-AM-06-00-900	-	
----	--------------------------	------	---	-----------------	---	---

PICATINNY

PT	einteilig slight long	BH 12	-	52-PT-12-00-900	-	
----	--------------------------	-------	---	-----------------	---	---

FÜR MERKEL (900)

	Bauhöhe	Zero	QD	FM	Ansicht QD
--	---------	------	----	----	------------

PULSAR Apex | Digisight | Trail - YUKON Sightline N455S/N475S

PA	einteilig	BH 10	-	50-PA-10-00-900	-	
----	-----------	-------	---	-----------------	---	---

PULSAR Trail 2 / LRF | Digisight Ultra N355/N450 LRF/N455 LRF

PA2	einteilig	BH 10	-	50-PA2-10-00-900	-	
-----	-----------	-------	---	------------------	---	---

PULSAR Thermion I-II/Pro/LRF | Thermion Duo DXP50/DXP55 - INFIRAY Tube TL35/TH35/TH35 SE/TH50/TS60 - LAHOUX Sight 35 - HIKMICRO Apex 4K Lite A40EL Stellar SH35/50/SQ35/50 | Stellar 2.0 SQ50 | Stellar 3.0 SH35/SH35L/SH50L/SQ35L/SQ50L/SX60L - NIGHT PEARL Marten TU420/TU430/TU450/TU650 GUIDE TU420/TU430/TU450/TU620/TU630/TU650 - THERMTEC Ares 335/360/635/660 | Ibex 335L | Oryx-L635/L650 - CONOTECH Night Arrow PARD DS35 LRF | Nightstalker 4K | Pantera 480/640/640 Zoom - PIXFRA Pegasus/Pegasus Pro | Volans V850/V850 LRF - NOCPIX ACE H50R/H50/L35 | Bolt L35R/ P25R

TH	einteilig	BH 24	-	50-TH-24-00-900	-	
----	-----------	-------	---	-----------------	---	---

PULSAR Digex N450/N455/C50 - INFIRAY Tube TH35 V2/TD50L/TH50 V2 - HIKMICRO Apex A50EL/A50T/A50TN/Pro A50P/Pro A50PL Stellar SX60L 3.0 - PARD DS35 - NOCPIX ACE S60R | ACE S60R | Nite D70R

DE	einteilig	BH 27	-	50-DE-27-00-900	-	
----	-----------	-------	---	-----------------	---	---

ATN Thor | Mars | X-Sight I + II

ATN	einteilig	BH 12	-	50-ATN-12-00-900*	-	
-----	-----------	-------	---	-------------------	---	---

*Ab Objektivdurchmesser 70 mm Art.Nr. **24-ATN-10** mitbestellen.
*From an objective diameter of 70 mm, item no. order the **24-ATN-10** at the same time.

ATN4/5 Thor 4/LT | X-Sight 4K Pro/ LTV/4K INT

ATN4/5	einteilig	BH 24	-	50-ATN4-24-00-900	-	
--------	-----------	-------	---	-------------------	---	---

YUKON Photon

YP	einteilig	BH 27	-	50-YP-27-00-900	-	
----	-----------	-------	---	-----------------	---	---

*Abbildung ähnlich.

DEDAL Hunter

DH	einteilig	BH 14	-	50-DH-14-00-900	-	
----	-----------	-------	---	-----------------	---	---



FÜR MERKEL (900)

	Bauhöhe	Zero	QD	FM	Ansicht QD
--	---------	------	----	----	------------

TVT Archer TSA

AR	einteilig	BH 13	-	50-AR-13-00-900	-	
----	-----------	-------	---	-----------------	---	---

PARD NV008P/LRF | SA 19/25/35/45 LRF - SYTONG HT60 | XM

PD	einteilig	BH 13	-	50-PD-13-00-900	-	
----	-----------	-------	---	-----------------	---	---

PARD NV008S/LRF | FT32 LRF

PD2	einteilig	BH 13	-	50-PD2-13-00-900	-	
-----	-----------	-------	---	------------------	---	---

GUIDE TS 450

GT	einteilig	BH 17	-	50-GT-17-00-900	-	
----	-----------	-------	---	-----------------	---	---

INFIRAY Rico RH35/RH50/RL42/RS75* | Rico 2 S75R*/H75R* (Adapter 24-IRR-15 mitbestellen) | Geni GL35R/GL35/GH50/GH50R

IRR	einteilig	BH 10	-	50-IRR-10-00-900	-	
-----	-----------	-------	---	------------------	---	---

INFIRAY Saim SCP19/SCL35/SCT35/SCH50/SCT35 V2 - LIEMKE Sperber 19/25/35 NIGHT PEARL Fox 19 Hunt/35 Elite II/35 Hunt - NOCPIX Slim L35/H35

IRS	einteilig	BH 16	-	50-IRS-16-00-900	-	
-----	-----------	-------	---	------------------	---	---

*Abbildung ähnlich.

HIKMICRO Thunder TH25/TH35/TE19 PRO/TE25 PRO/TQ35 PRO/TQ50 PRO Panther PH35L/PH50L/PQ35L/PQ50L - Cheetah C32F-S/SL/SN/SNL

HMT	einteilig	BH 18	-	50-HMT-18-00-900	-	
-----	-----------	-------	---	------------------	---	---



FÜR **12MM PRISMA**

FÜR 12MM PRISMA (950)

	Bauhöhe	Zero	QD	FM	Ansicht QD
--	---------	------	----	----	------------

RINGMONTAGE 1"/26 MM

Ø 1"/26	einteilig	BH 16 BH 19 BH 22	-	50-26-16-00-950 50-26-19-00-950 50-26-22-00-950	-	
---------	-----------	-------------------------	---	---	---	--

RINGMONTAGE 30 MM

Ø 30	einteilig	BH 16 BH 19 BH 22 BH 25	-	50-30-16-00-950 50-30-19-00-950 50-30-22-00-950 50-30-25-00-950	-	
------	-----------	----------------------------------	---	--	---	--

RINGMONTAGE 34 MM

Ø 34	einteilig	BH 16 BH 19 BH 22 BH 25	-	50-34-16-00-950 50-34-19-00-950 50-34-22-00-950 50-34-25-00-950	-	
------	-----------	----------------------------------	---	--	---	--

RINGMONTAGE 35 MM

Ø 35	einteilig	BH 16 BH 19 BH 22	-	50-35-16-00-950 50-35-19-00-950 50-35-22-00-950	-	
------	-----------	-------------------------	---	---	---	--

RINGMONTAGE 36 MM

Ø 36	einteilig	BH 16 BH 19 BH 22	-	50-36-16-00-950 50-36-19-00-950 50-36-22-00-950	-	
------	-----------	-------------------------	---	---	---	--

RINGMONTAGE 40 MM

Ø 40	einteilig	BH 16 BH 19 BH 22	-	50-40-16-00-950 50-40-19-00-950 50-40-22-00-950	-	
------	-----------	-------------------------	---	---	---	--

	Bauhöhe	Zero	QD	FM	Ansicht QD
--	---------	------	----	----	------------

SWAROVSKI SR

SR	einteilig	BH 10	-	50-SR-10-00-950	-	
----	-----------	-------	---	-----------------	---	--

ZEISS ZM/VM

VM	einteilig	BH 9	-	50-VM-09-00-950	-	
----	-----------	------	---	-----------------	---	--

LM Schiene

LM	einteilig	BH 17	-	50-LM-17-00-950	-	
----	-----------	-------	---	-----------------	---	--

PICATINNY / PICATINNY Long

PT	einteilig	BH 20	-	50-PT-20-00-950	-	
----	-----------	-------	---	-----------------	---	--

*Abbildung ähnlich.

MULTIRAIL/PICATINNYRAIL

MULTIRAIL/PICATINNYRAIL

Picatinny - Blaser

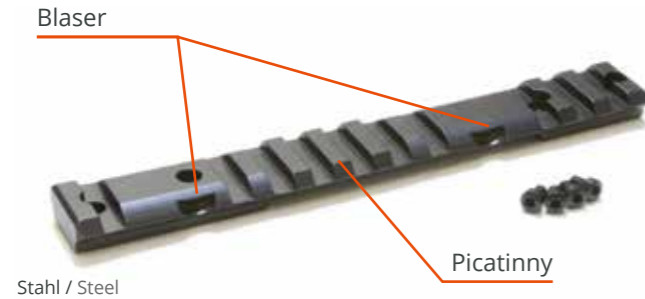

Stahl / Steel

Picatinny



Stahl / Steel

Waffe	Bestellnummer Multirail Picatinny - Blaser
Anschütz 1771	12-PT-800-00-053
Anschütz 1780	12-PT-800-00-151
Benelli Argo	12-PT-800-00-273
Benelli Lupo	12-PT-800-00-054
Beretta Mod. BRX1	12-PT-800-00-051
Bergara BA 13	12-PT-800-00-034
Bergara B 14 LA*	12-PT-800-00-041
Bergara B 14 SA*	12-PT-800-00-042
Bergara B 14 Premier Series LA*	12-PT-800-00-064
Bergara B 14 Premier Series SA*	12-PT-800-00-063
CZ600 Lux/Range Long	12-PT-800-00-070
CZ600 Lux/Range Medium	12-PT-800-00-069
CZ600 Lux/Range Mini	12-PT-800-00-068
FN Browning BAR/BAR 4X/Maral/Maral 4X	12-PT-800-00-003
FN Browning A - Bolt 3 LA*	12-PT-800-00-037
FN Browning A - Bolt 3 SA*	12-PT-800-00-038
Franchi Horizon LA*	12-PT-800-00-050
Franchi Horizon SA*	12-PT-800-00-056
Haenel Jäger 10 ab Nr. 921	12-PT-800-00-226
Heckler & Koch SLB 2000	12-PT-800-00-187
Heym SR30	12-PT-800-00-206
Heym SR21	12-PT-800-00-306
Howa 1500 LA*	12-PT-800-00-218
Howa 1500 SA*	12-PT-800-00-217
Howa 1500 MA*	12-PT-800-00-219
Krico 600	12-PT-800-00-033
Marlin 1895/444/338/336/308	12-PT-800-00-036
Mauser M12 (alt bis SN 29.999)	12-PT-800-00-020
Mauser M12 (neu ab SN 30.000)	12-PT-800-00-043
Mauser M18	12-PT-800-00-007
Mauser 25	12-PT-800-00-071
Mauser K98 (ohne Wulst)	12-PT-800-00-026
Remington 700 LA*	12-PT-800-00-009
Remington 700 SA*	12-PT-800-00-008
Remington 7400/7600/750	12-PT-800-00-013
Rohling	12-PT-800-00-000

Bestellnummer Picatinny	Bestellnummer Picatinny - 20MOA
-	-
11-PT-ST-00-151	-
11-PT-ST-00-273	-
11-PT-ST-00-054	-
-	-
11-PT-ST-00-034	-
11-PT-ST-00-041	11-PT-ST-00-041-20MOA
11-PT-ST-00-042	11-PT-ST-00-042-20MOA
11-PT-ST-00-064	11-PT-ST-00-064-20MOA
11-PT-ST-00-063	11-PT-ST-00-063-20MOA
11-PT-ST-00-070	11-PT-ST-00-070-20MOA
11-PT-ST-00-069	11-PT-ST-00-069-20MOA
11-PT-ST-00-068	-
11-PT-ST-00-003	-
11-PT-ST-00-037	-
11-PT-ST-00-038	-
11-PT-ST-00-050	-
11-PT-ST-00-056	-
11-PT-ST-00-226	-
11-PT-ST-00-187	-
11-PT-ST-00-206	-
11-PT-ST-00-306	-
11-PT-ST-00-218	11-PT-ST-00-218-20MOA
11-PT-ST-00-217	11-PT-ST-00-217-20MOA
11-PT-ST-00-219	-
11-PT-ST-00-033	-
11-PT-ST-00-036	-
11-PT-ST-00-020	-
11-PT-ST-00-043	-
11-PT-ST-00-007	11-PT-ST-00-007-20MOA
11-PT-ST-00-071	-
11-PT-ST-00-026	11-PT-ST-00-026-20MOA
11-PT-ST-00-009	11-PT-ST-00-009-20MOA
11-PT-ST-00-008	11-PT-ST-00-008-20MOA
11-PT-ST-00-013	-
11-PT-ST-00-000	-

* LA = long action; SA = short action; MA = mini action

Waffe	Bestellnummer Multirail Picatinny - Blaser
Rössler Titan Alpha / Titan 6 / Signature	12-PT-800-00-459
Sako 85	12-PT-800-00-052
Sauer 100/101	12-PT-800-00-014
Sauer 202	12-PT-800-00-407
Sauer 202 Magnum	12-PT-800-00-408
Sauer 303 Neue SN: L... / 404	12-PT-800-00-650
Steyr Mod. - SBS/SM12/Classic Größe L	12-PT-800-00-018
Steyr Mod. - SBS/SM12/Classic Größe M	12-PT-800-00-022
Steyr Mod. - SBS/SM12/CL II/Classic Größe S	12-PT-800-00-025
Steyr Mod. - SBS/SM12/CL II/Classic Größe SL	12-PT-800-00-039
Tikka T3/T3x	12-PT-800-00-400
Tikka M55	12-PT-800-00-401
Tikka Mod. T1x	12-PT-800-00-404
Winchester M70 LA*	12-PT-800-00-067
Winchester M70 SA*	12-PT-800-00-066
Zoli 1900	12-PT-800-00-305
11 mm Prisma	12-PT-800-00-055

weitere Modelle folgen

Bestellnummer Picatinny	Bestellnummer Picatinny - 20MOA
-	-
11-PT-ST-00-052	-
11-PT-ST-00-014	11-PT-ST-00-014-20MOA
11-PT-ST-00-407	11-PT-ST-00-407-20MOA
11-PT-ST-00-408	11-PT-ST-00-408-20MOA
-	-
11-PT-ST-00-018	-
11-PT-ST-00-022	-
11-PT-ST-00-025	-
11-PT-ST-00-039	-
11-PT-ST-00-400	11-PT-ST-00-400-20MOA
11-PT-ST-00-401	-
11-PT-ST-00-404	-
11-PT-ST-00-067	-
11-PT-ST-00-066	-
11-PT-ST-00-305	-
11-PT-ST-00-055	-

Waffensystem	Bestellnummer
Mauser 25	13-800-ST-00-071
Weaver/Picatinny z.B. Merkel Helix	13-800-ST-00-200

Super flach mit nur 5mm Bauhöhe. Speziell für Blasermontagen.



Passend für Merkel Helix / Steel Action / Sako S20 / Benelli Lupo etc.; Achsmaß der Klemmelemente 110 mm
Fits for Merkel Helix / Steel Action / Sako S20 / Benelli Lupo etc.; Axis dimension of clamp 110 mm

BASEN - WEAVER - ZWEITEILIG

BASEN - WEAVER - TWO PIECE



Aluminium

Bestellnr.: 10-00-WKZ
Order number: 10-00-WKZ

Fabrikat	Modell	WKZ	Fabrikat	Modell	WKZ	Fabrikat	Modell	WKZ
Anschütz	1780	151	Heckler & Koch	SLB 2000-Light	187	Rössler	Titan Alpha / Titan 3 / Titan 6 / Signature	459
Anschütz	1574	154	Heym	SR 20	060	Santa Barbara	Mauser	044
Benelli	ARGO	273	Heym	SR 21	306	Sauer	200	059
Bergara	BA14	040	Heym	SR 30	206	Sauer	202	406
Carl Gustav	1900	005	Howa	1500	216	Sauer	80, 90, 92	015
Carl Gustav	2000	194	Krico	600 / 700 / 900 / 902	006	Sauer	100 / 101	014
Carl Gustav	3000	215	Mauser	225 Titan	145	Steyr	Mod. L	093
Carl Gustav	4000	259	Mauser	K 98 / M12 (alt bis SN 29.999)	010	Steyr	Mod. M Luxus L M S	086
Fabarm	Iris	403	Mauser	M12 (neu ab SN 30.000)	043	Steyr	Mod. SL	017
FN Browning	European	143	Mauser	M18	007	Steyr	SBS96 / SM12 / Classic	027
FN Browning	Brow Mauser	004	Merkel	SR 1	186	Swiss Arms	SHR 970	175
FN Browning	BAR/BAR 4X/Maral/Maral 4X	003	Merkel	SR 1 Basic	286	Voere	Kufstein 2165	021
FN Browning	BLR	103	Remington	700	012	Voere	Titan II	045
Haenel	Jäger 10, ab Nr. 921	226	Remington	750 / 740 / 742 / 760	074	Zastava	Mod. 70	049
						Zoli	1900 Repetierer	305

ABMESSUNGEN

DIMENSIONS

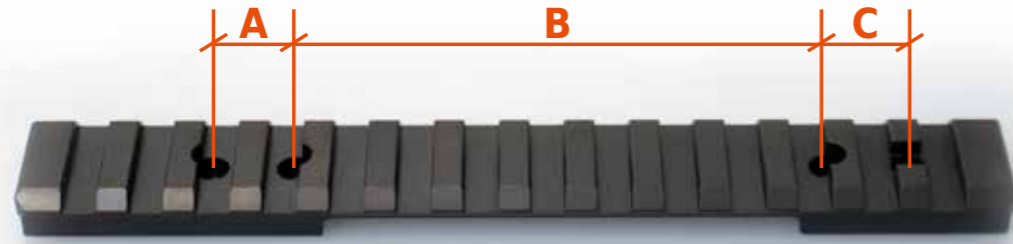

Fabrikat	Modell	W-Kz	Maß A	Maß B	Maß C
Anschütz	1771	053	12,7	53,8	2x 12,7
Anschütz	1780	151	12,7	76,5	12,7
Benelli	Argo	273	12,7	81	12,7
Benelli	Lupo	054	21,9	96,9	21,9
Beretta	BRX1	051	36,5	26,5	26,5
Bergara	BA13	034	21,7	20	21,7
Bergara	B14 LA*	041	21,9	113,9	15,3
Bergara	B14 SA*	042	21,9	92,2	15,3
Bergara	B14 Premier Series LA*	064	21,9	113,9	15,3
Bergara	B14 Premier Series SA*	063	21,9	92,2	15,3
CZ600	Lux/Range Long	070	21,9	113,9	15,3
CZ600	Lux/Range Medium	069	21,9	92,2	15,3
CZ600	Lux/Range Mini	068	21,9	77,2	15,3
FN Browning	BAR//BAR 4X/Maral Maral 4X	003	12,7	81	12,7
FN Browning	A-Bolt 3 LA*	037	21,84	98,1	21,84
FN Browning	A-Bolt 3 SA*	038	21,84	82,6	21,84
Franchi	Horizon LA*	050	21,84	107,8	15,3
Franchi	Horizon SA*	056	21,84	89,7	15,3
Haenel	Jäger 10, ab Nr. 921	226	21,9	113,9	15,24
Heckler & Koch	SLB 2000	187	21,9	98,5	2x 15,4
Heckler & Koch	SL7 / HK630 / HK770 / HK940	-	-	-	-
Heym	SR 21	306	21,9	111	12,8
Heym	SR 30	206	21,9	118,5	12,8
Howa	1500 LA*	218	21,8	113,9	15,2
Howa	1500 SA*	217	21,84	98,55	15,24
Howa	1500 MA*	219	21,84	80,24	15,24
Krico	600	033	21,84	82,6	12,8
Marlin	1895 / 444 / 338 / 336 / 308	036	12,8	69,9	12,8

Fabrikat	Modell	W-Kz	Maß A	Maß B	Maß C
Mauser	K 98 (ohne Wulst)	026	22	102,4	12,8
Mauser	M12 (alt bis SN 29.999)	020	21,9	101,7	12,7
Mauser	M12 (neu ab SN 30.000)	043	21,9	113,9	15,3
Mauser	M18	007	21,84	114	15,3
Remington	7400 / 7600 / 750	013	21,9	52,3	15,24
Remington	700 SA*	008	21,9	92,2	15,3
Remington	700 LA*	009	21,9	113,9	15,3
Rössler	Titan 6 / Signature	459	21,9	110	21,9
Sako	85 Größe XS/S/M/L	052	-	-	-
Sauer	100 / 101	014	21,84	114	15,3
Sauer	202	407	21,84	94,2	21,84
Sauer	202 Magnum	408	21,84	100,2	21,84
Sauer	303 ab SN L:... / 404	650	-	-	-
Steyr	Mod. - SBS/SM12/CL II/ Classic Größe SL	039	21,84	56	21,84
Steyr	Mod. - SBS/SM12/CL II/ Classic Größe L	018	21,84	76	21,84
Steyr	Mod. - SBS/SM12/CL II/ Classic Größe M	022	21,84	83	21,84
Steyr	Mod. - SBS/SM12/CL II/ Classic Größe S	025	21,84	87,5	21,84
Tikka	T1x	404	21,84	63,9	21,84
Tikka	T3/T3x	400	21,9	82,2	21,9
Tikka	M55	401	22,15	91,25	22,15
Winchester	M70 SA*	066	21,84	82,5	21,84
Winchester	M70 LA*	067	21,84	96,5	21,84
Zoli	1900	305	21,84	95,8	12,74
11 mm Prisma	-	055	-	-	-

* LA = long action; SA = short action; MA = mini action



DOUBLE SIGHT

DOUBLE SIGHT

Bestellnr.: 10-00-WKZ
Order number: 10-00-WKZ



Ringoberteil mit Universalschnittstelle für alle INNOMOUNT Ringmontagen

Ring upper part with universal interface for all INNOMOUNT ringmounts



Ringdurchmesser	Ausrichtung 90°	Ausrichtung 45°
1"/26 mm	21-26-90	21-26-45
30 mm	21-30-90	21-30-45
34 mm	21-34-90	21-34-45
35 mm	21-35-90	21-35-45
36 mm	21-36-90	21-36-45
40 mm	21-40-90	21-40-45

Artikelnr. für Aufpreis

Article number for additional charge

Bestellbeispiel
Ordering example
1x | Montage/Mount | 50-30-14-00-200
1x | Ringoberteil/Ring upper part | 21-30-90

Ringoberteil mit Universalschnittstelle für alle INNOMOUNT Ringmontagen mit Aluringen

Ring upper part with universal interface for all INNOMOUNT ringmounts with alu rings

Ringdurchmesser	Ausrichtung 90°	Ausrichtung 45°
1"/26 mm	22-26-90	22-26-45
30 mm	22-30-90	22-30-45
34 mm	22-34-90	22-34-45
35 mm	22-35-90	22-35-45
36 mm	22-36-90	22-36-45
40 mm	22-40-90	22-40-45



Austauschteil
Replacement part

2/3 Ring mit Universalschnittstelle für alle Schienen und Ringversionen

2/3 ring with universal interface for all rail and ring versions

Ringdurchmesser	Ausrichtung 90°	Ausrichtung 45°
1"/26 mm	23-26-90	23-26-45
30 mm	23-30-90	23-30-45
34 mm	23-34-90	23-34-45
36 mm	23-36-90	23-36-45
40 mm	23-40-90	-



Adapter mit
Universalschnittstelle
Adapter with
universal interface

		Aufsatz
Docter Sight	BH5	24-DS-05
Aimpoint Micro	BH5	24-AM-05
Picatinny	BH10	24-PT-10
Picatinny	BH15	24-PT-15
Aimpoint Acro	BH7	24-AC-07*

* Passend nur in Verbindung mit 24-AM-05
* Only suitable in combination with 24-AM-05

Adapterplatten für Multifunktionsmontage

Adapter plate for multifunction mount

Dipol TFA	24-DI-04	InfiRay CL42 Gen.2 CH50 V1 & V2 MAL 25 & MAL 38 MAH 50/R Liemke Merlin 42 & 50	24-IRS-03
Guide TA435 TA450 Burris JSA	24-GT-05	InfiRay CML 25 Liemke Merlin 19 & 25	24-IRM-12
Gun Tec Oberon	24-GTO-05	Limke Merlin 35 Luchs 1 & 2	24-LST-05
Hikmicro Thunder TE 19 PRO TH 35C TH 35 PC PRO TQ 35C PRO TQ 50 PRO Serie 1.0 & 2.0	24-HMT-06	Night Pearl Seer 35 & 50	24-NPS-10
InfiRay CL42 Gen.1	24-IRS-05		



ARTIKELNUMMER

ITEM NUMBER

BRÜCKENSCHWENKMONTAGEN

SWING MOUNTS

Montagetyp / Mounting type

Oberteil / Upper part

Bauhöhe Grundkörper / Construction height base
Angaben in mm / dimensions in mm

Bauhöhe/Kröpfung - Vorderfuss
Construction height/offset - front foot
Angaben in mm / dimensions in mm

Bauhöhe Distanzrolle
Construction height - Distance rings
Angaben in mm / dimensions in mm

Verschlusskörper / Locking system

Waffenkennzahl* / ID No.*

70-SR-12-002-010-150-WKZ

- 26 – Ringe 25,4/26 mm
- 30 – Ringe 30 mm
- 34 – Ringe 34 mm
- 35 – Ringe 35 mm
- 36 – Ringe 36 mm
- 40 – Ringe 40 mm
- VM – Zeisschiene
- LM – 70° Prismenschiene
- SR – Swarovskischiene
- PT – Picatinny
- PA – Pulsar
- YP – Yukon Photon
- ATN – X-Sight I+II
- ATN4 – X-Sight 4K
- ...

- 002 – gerade; BH 2 mm
- 004 – gerade; BH 4 mm
- 006 – gerade; BH 6 mm
- 010 – gerade; BH 10 mm
- 206 – gekröpft 20 mm; BH 6 mm
- 406 – gekröpft 40 mm; BH 6 mm

- WKZ – siehe Seite 4
- 000 – siehe Seite 75
- 150 – Hebelverschluss (15 mm Prisma)
- 160 – Drehbolzenverschluss (EAW)
- 010 – Bauhöhe 1 mm
- 015 – Bauhöhe 1,5 mm
- 020 – Bauhöhe 2 mm
- ...
- 125 – Bauhöhe 12,5 mm
- 130 – Bauhöhe 13 mm
- 150 – Bauhöhe 15 mm

70 – Brückenschwenkmontage



Hebelverschluss (15 mm Prisma)

SR	Swarovski SR Schiene	70-SR-12-XXX-YYY-150-WKZ
VM	Zeiss ZM/VM Schiene	70-VM-12-XXX-YYY-150-WKZ
LM	LM Schiene	70-LM-17-XXX-YYY-150-WKZ
PA	Pulsar APEX / Digi-sight / Trail	70-PA-14-XXX-YYY-150-WKZ
PA2	Pulsar Trail2 / Digi-sight Ultra N450 & N455	70-PA2-14-XXX-YYY-150-WKZ
TH	Pulsar Thermion	70-TH-23-XXX-YYY-150-WKZ
DE	Pulsar Digex	70-DE-26-XXX-YYY-150-WKZ
YP	Yukon	70-YP-30-XXX-YYY-150-WKZ
DH	Dedal - Hunter	70-DH-16-XXX-YYY-150-WKZ
ATN	ATN	70-ATN-15-XXX-YYY-150-WKZ
ATN4	ATN 4	70-ATN4-23-XXX-YYY-150-WKZ
IRS	InfiRay Saim	70-IRS-15-XXX-YYY-150-WKZ
IRX	InfiRay Xsight	70-IRX-15-XXX-YYY-150-WKZ
IRR	InfiRay Rico	70-IRR-14-XXX-YYY-150-WKZ
PD	Pard 008 / SA Series	70-PD-15-XXX-YYY-150-WKZ
PD2	Pard 008S / 008S LRF	70-PD2-15-XXX-YYY-150-WKZ
AR	TVT - Archer	70-AR-14-XXX-YYY-150-WKZ
GT	Guide TS450	70-GT-28-XXX-YYY-150-WKZ
PT	Picatinny	70-PT-18-XXX-YYY-150-WKZ
HMT	Hikmicro	70-HMT-18-XXX-YYY-150-WKZ
Ø 40	Ring 40 mm*	70-40-17-XXX-YYY-150-WKZ
Ø 36	Ring 36 mm*	70-36-17-XXX-YYY-150-WKZ
Ø 35	Ring 35 mm*	70-35-17-XXX-YYY-150-WKZ
Ø 34	Ring 34 mm*	70-34-17-XXX-YYY-150-WKZ
Ø 30	Ring 30 mm*	70-30-17-XXX-YYY-150-WKZ
Ø 26	Ring 26 mm*	70-26-17-XXX-YYY-150-WKZ

Drehbolzenverschluss EAW

SR	Swarovski SR Schiene	70-SR-12-XXX-YYY-160-WKZ
VM	Zeiss ZM/VM Schiene	70-VM-12-XXX-YYY-160-WKZ
LM	LM Schiene	70-LM-17-XXX-YYY-160-WKZ
PA	Pulsar APEX / Digi-sight / Trail	70-PA-14-XXX-YYY-160-WKZ
PA2	Pulsar Trail2 / Digi-sight Ultra N450 & N455	70-PA2-14-XXX-YYY-160-WKZ
TH	Pulsar Thermion	70-TH-23-XXX-YYY-160-WKZ
DE	Pulsar Digex	70-DE-26-XXX-YYY-160-WKZ
YP	Yukon	70-YP-30-XXX-YYY-160-WKZ
DH	Dedal - Hunter	70-DH-16-XXX-YYY-160-WKZ
ATN	ATN	70-ATN-15-XXX-YYY-160-WKZ
ATN4	ATN 4	70-ATN4-23-XXX-YYY-160-WKZ
IRS	InfiRay Saim	70-IRS-15-XXX-YYY-160-WKZ
IRX	InfiRay Xsight	70-IRX-15-XXX-YYY-160-WKZ
IRR	InfiRay Rico	70-IRR-14-XXX-YYY-160-WKZ
PD	Pard 008 / SA Series	70-PD-15-XXX-YYY-160-WKZ
PD2	Pard 008S / 008S LRF	70-PD2-15-XXX-YYY-160-WKZ
AR	TVT - Archer	70-AR-14-XXX-YYY-160-WKZ
GT	Guide TS450	70-GT-28-XXX-YYY-160-WKZ
PT	Picatinny	70-PT-18-XXX-YYY-160-WKZ
HMT	Hikmicro	70-HMT-18-XXX-YYY-160-WKZ
Ø 40	Ring 40 mm*	70-40-17-XXX-YYY-160-WKZ
Ø 36	Ring 36 mm*	70-36-17-XXX-YYY-160-WKZ
Ø 35	Ring 35 mm*	70-35-17-XXX-YYY-160-WKZ
Ø 34	Ring 34 mm*	70-34-17-XXX-YYY-160-WKZ
Ø 30	Ring 30 mm*	70-30-17-XXX-YYY-160-WKZ
Ø 26	Ring 26 mm*	70-26-17-XXX-YYY-160-WKZ

* Ringmontagen sind in der Bauhöhe gemäß Tabelle sowie in +3 und +6 mm höheren Ausführungen erhältlich. Bitte bei der Bestellangabe berücksichtigen.
* Ring mountings are available in the construction heights as listed in the table as well as in +3 and +6 mm higher versions. Please take this into account for ordering.
XXX = Bauhöhe Vorderfuss | YYY = Bauhöhe Distanzrolle | WKZ (siehe Seite 3) / ohne WKZ = 000
XXX = Construction height front foot | YYY = Construction height distance rings | WKZ (see page 3) / without WKZ = 000 (see page 27)

BRÜCKENSCHWENKMONTAGEN

SWING MOUNTS



Vorderfuß Bestellnr.: 24-VF-...
Front Foot order number: 24-VF-...

Bauhöhe BV	Kröpfung	XXX
2 mm	gerade	002
4 mm	gerade	004
6 mm	gerade	006
10 mm	gerade	010
6 mm*	gekröpft; 20 mm	206
6 mm*	gekröpft; 40 mm	406

* bei Abstand der mittleren Basenbohrungen (B) größer 104 mm
* for distance of middle whols of bases (B) larger than 104 mm

Distanzrolle Bestellnr.: 24-DR-...
Distance Rings order number: 24-DR-...

Bauhöhe BD	YY	YYY
1 mm	0,8 - 1,2	010
1,5 mm	1,3 - 1,7	015
2 mm	1,8 - 2,2	020
2,5 mm	2,3 - 2,7	025
3 mm	2,8 - 3,2	030
3,5 mm	3,3 - 3,7	035
... Höhe durchgehend bis 13 mm		
13 mm	12,8 - 13,2	130
15 mm		150

Distanzrolle verstellbar
0 und +/- 0,15 und +/- 0,30
Distance Rings adjustable
0 and +/- 0,15 and +/- 0,30



BESTELLBEISPIEL

ORDER EXAMPLE

70-SR-12-XXX-YYY-150-000 (für WKZ = 000)

1. Messen des Bauhöhen-Unterschieds (BU)

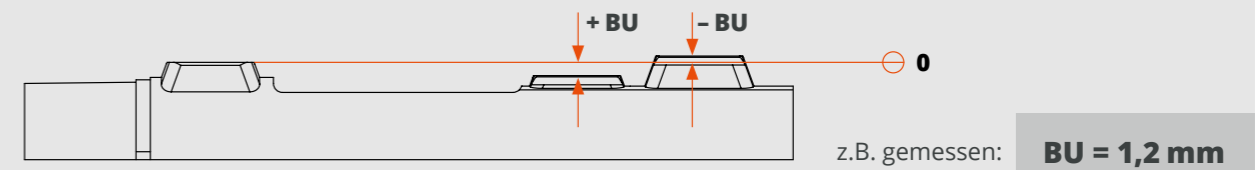

2. Bauhöhe Vorderfuß (BV)

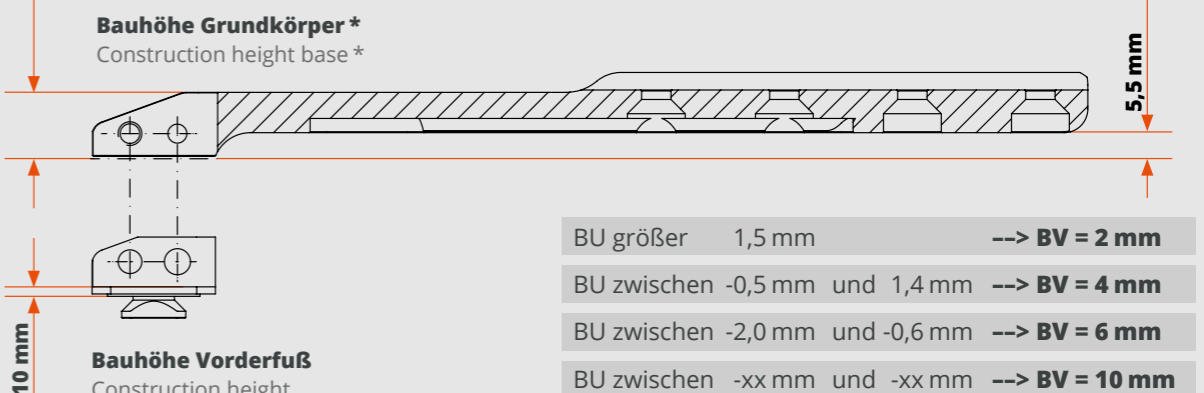

z.B.: BU = 1,2 mm --> BV = 4 mm: **XXX = 004**

3. Bauhöhe Distanzrolle (BD)

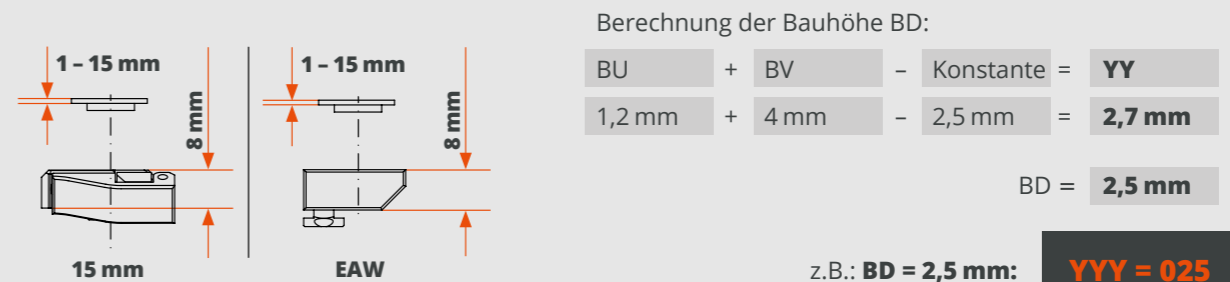

70-SR-12-004-025-150-000

TAKTISCHE MONTAGE - FLEX

TACTICAL MOUNT - FLEX



0 MOA → ∞

Bauhöhe / Construction height

Angaben in mm / dimensions in mm

Kröpfung / Offset

Angaben in mm / dimensions in mm

Waffenkennzahl / Weapon code

Vorneigung / Pre-tilt

Angaben in MOA / data in MOA

Montagetyp / Mounting type

Oberteil / Upper part

64-30-23-00-200-20MOA

200 - Picatinny

64 - QD einteilig Flex
65 - FM einteilig Flex

30 - Ringe 30 mm
34 - Ringe 34 mm
VM - Zeiss-Schiene
SR - Swarovski-Schiene

Ringoberteil mit Universalschnittstelle für alle Taktische Montagen

Ring upper part with universal interface for all Tactical mounts

Ringdurchmesser		
30 mm	vorne	26-30-00
	hinten	26-30-01-20MOA
		26-30-02-20MOA
34 mm	vorne	26-34-00
	hinten	26-34-01-20MOA
		26-34-02-20MOA

Artikelnr. für Aufpreis
Article number for additional charge

Ringoberteil mit Universalschnittstelle für alle Taktische Montagen

Ring upper part with universal interface for all Tactical mounts



Austauschteil
Replacement part

Ringdurchmesser		
30 mm	vorne	27-30-00
	hinten	27-30-01-20MOA
		27-30-02-20MOA
34 mm	vorne	27-34-00
	hinten	27-34-01-20MOA
		27-34-02-20MOA

Vorneigung veränderbar
0 - 20MOA / 20 - 40 MOA
changable pre-tilt:
0 - 20MOA / 20 - 40MOA

Ringe auswechselbar
changeable rings



PATENTED

1. Ringe tauschen

Change rings



0-MOA



2. Ringe drehen

Turn rings



20-MOA



Durchmesser	Bauhöhe	Vorneigung	Bestellnummer Schnellspannmontage (QD)	Bestellnummer Festmontage (FM)
30	23	0 - 20MOA	64-30-23-00-200-20MOA	65-30-23-00-200-20MOA
30	23	20 - 40MOA	64-30-23-00-200-40MOA	65-30-23-00-200-40MOA
34	21	0 - 20MOA	64-34-21-00-200-20MOA	65-34-21-00-200-20MOA
34	21	20 - 40MOA	64-34-21-00-200-40MOA	65-34-21-00-200-40MOA



Abbildung zeigt 2 Ringpaare mit Universalschnittstelle.
Picture shows 2 ring pairs with universal interface.

Durchmesser	Bauhöhe	Vorneigung	Bestellnummer Ringpaar
30	12	0 - 20MOA	28-30-12-20MOA
30	12	20 - 40MOA	28-30-12-40MOA
34	10	0 - 20MOA	28-34-10-20MOA
34	10	20 - 40MOA	28-34-10-40MOA

TAKTISCHE MONTAGE - FLEX

TACTICAL MOUNT - FLEX



50 mm Offset

Kröpfung + 50mm durch Adapterplatte
Offset +50mm with Offsetadapter

0 - 20MOA Vorneigung bei Ringmontage
0 - 20MOA pre-tilt with rings



PATENTED

Abbildung zeigt Montage mit Universalschnittstelle.
Picture shows mounting with universal interface.

Durchmesser / Schiene	Bauhöhe	Vorneigung	Bestellnummer Schnellspannmontage (QD)	Bestellnummer Festmontage (FM)
30	34	0 - 20MOA	64-30-34-50-200-20MOA	65-30-34-50-200-20MOA
34	32	0 - 20MOA	64-34-32-50-200-20MOA	65-34-32-50-200-20MOA
Swarovski	24	ohne	64-SR-24-50-200	65-SR-24-50-200
Zeiss	23	ohne	64-VM-23-50-200	65-VM-23-50-200
Swarovski	24	20MOA	64-SR-24-50-200-20MOA	65-SR-24-50-200-20MOA
Zeiss	23	20MOA	64-VM-23-50-200-20MOA	65-VM-23-50-200-20MOA



Adapterplatte	Bauhöhe	Bestellnummer
Ring	11 mm	28-00-11-50
Zeiss	12 mm	28-VM-12-50
Swarovski	13 mm	28-SR-13-50
Zeiss	12 mm	28-VM-12-50-20MOA
Swarovski	13 mm	28-SR-13-50-20MOA

Adapterplatte wird ohne Ringe geliefert.
Offsetadapter delivery without rings.

INN@MOUNT

by INNOGUN

